

Vox[®] Folding Table



nienkämper

VOX® FOLDING TABLE | BASE, SURFACE, EDGE DETAILS

Surface Shapes

Tops are 1" thick for Solid base and 3/4" thick for Tubular base. Two shapes are available for each base style.

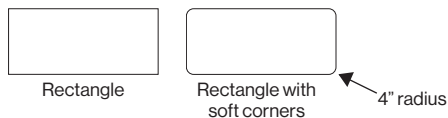

Finishes

All standard Nienkamper veneer and laminates including white marker board laminate.

Edge Details

Tubular base with 3/4" thick top



3/4" thick 16 degree Taper Edge (TE-16)

A = 1-1/4"

3/4" thick Self Edge (SE)

Solid base with 1" thick top

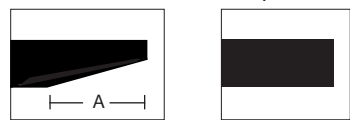

1" thick 16 degree Taper Edge (TE-16)

A = 2-1/8"

1" thick Self Edge (SE)

The edge detail at the seam is always in self edge with same finish as the top i.e. veneer or P-Lam.

Bases

Two types of bases are available for Vox® Folding Conference Tables, Tubular Bases and Solid Bases. Tubular Bases have two sizes, small tubular bases for folding tables 96"l or below and large tubular bases for folding tables 111"l & 120"l. Solid bases accommodate tables from 111"l & 120"l.

Bases are available in polished chrome or Black Powder Coat finish.



Side Elevation of Base

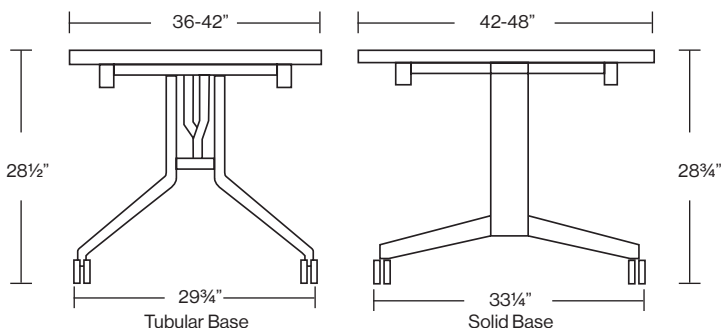

Sizes

Vox Folding Conference Tables are available in the following sizes:

Type of Base	Dimension		
	Length	Width	Height
Tubular Base	80", 84" & 96"	36" & 42"	28 1/2"
	111" & 120"	42"	
Solid Base	113" & 120"	42" & 48"	28 3/4"

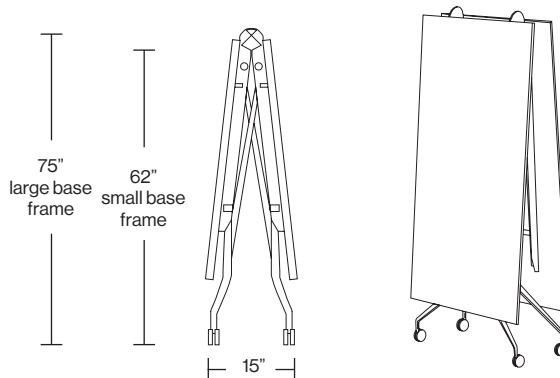
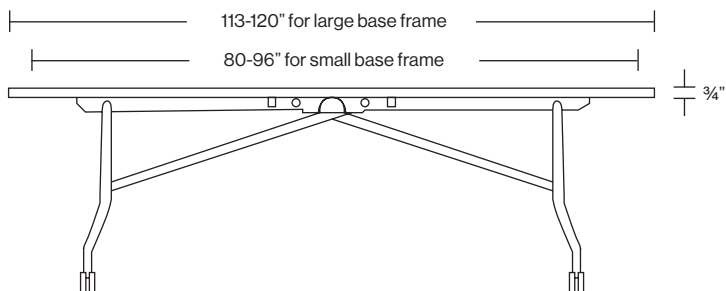

Tubular Base

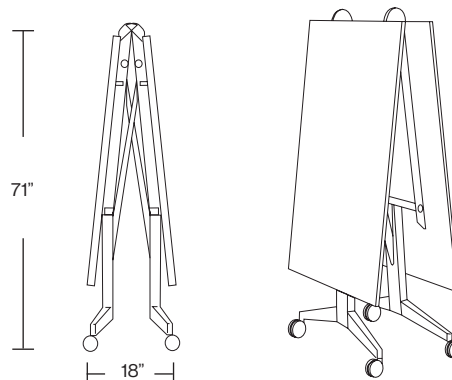
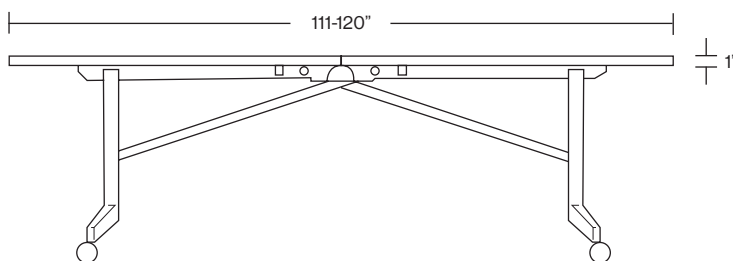

Solid Base

VENEERS

All wood surfaces are protected with a durable polyurethane clear laquer with UV inhibitor. This finish is known for its exceptional durability, as well as abrasion, chemical, impact and scratch resistance. Standard sheen level is 45 degrees. Optional 10 and 35 degree sheen levels are available on request at no additional cost.

Wood Species	Order Code	Veneer/Stain	Upcharge
Maple	F-01	Natural Maple	No upcharge applies.
	F-02	Natural Curly Maple - Rotary Cut	Add 15%.
	F-03	Natural Bird's Eye Maple - Rotary Cut	Call Customer Service for pricing.
	F-04	Maple Stained Pear	No upcharge applies.
Cherry	F-05	Natural Cherry	No upcharge applies.
	F-06	Standard Cherry	No upcharge applies.
	F-07	Cherry Stained Amber	No upcharge applies.
	F-08	Cherry Stained Auburn	No upcharge applies.
	F-09	Cherry Stained Burgundy	No upcharge applies.
Mahogany	F-10	Light Mahogany	No upcharge applies.
	F-11	Medium Mahogany	No upcharge applies.
	F-12	Dark Mahogany	No upcharge applies.
	F-13	Red Mahogany	No upcharge applies.
Anagre	F-14	Natural Figured Anagre - Qtr. Cut Book-Match	Add 15%.
	F-15	Figured Anagre Stained Amber - Qtr. Cut Book-Match	Add 15%.
Sycamore	F-16	Natural Figured Sycamore - Qtr. Cut Book-Match	Add 15%.
Walnut	F-17	Burnt Walnut	No upcharge applies.
	F-19	Natural Walnut	No upcharge applies.
	F-24	Carbon Grey Walnut	No upcharge applies.
White Oak	F-18	Natural White Oak - Flat Cut Book-Match (10° sheen)	No upcharge applies.
		Natural White Oak - Rift Cut Slip-Match (10° sheen)	Add 5%
Sapele – Ribbon Stripe	F-20	Natural Ribbon Strip Sepele - Qtr. Cut Slip-Match	No upcharge applies.
Moabe (Cherry substitute)	F-21	Natural Moabe - Quarter - Qtr. Cut Book-Match	No upcharge applies.
Cape Coast Walnut	F-22	Dark Cape Coast Walnut - Qtr. Cut Slip-Match	No upcharge applies.
	F-23	Natural Cape Coast Walnut - Qtr. Cut Slip-Match	No upcharge applies.
Ash	F-25	Slate Grey Ash - Qtr. Cut Slip-Match	No upcharge applies.

VENEER GRAIN OPTIONS

Nienkamper products utilize the best quality veneers available, and, combined with Nienkämper's patented veneering systems, create work environments of incredible quality and beauty.

All veneer furniture comes standard with flat cut book-match veneer; flat cut slip-match veneer can also be specified. Quarter cut slip-match and quarter cut book-match veneers are available at a 5% upcharge. Figured Anagre and Figured Sycamore veneers are Quarter cut book-matched. Bird's Eye Maple and Curly Maple are rotary cut.

Facet Edge, Taper edge and Flowform edge tops with veneer are manufactured with a solid wood edge. All edges are then veneer wrapped to create a seamless profile top.

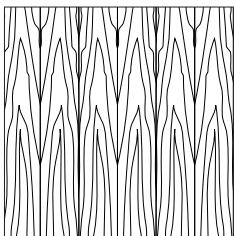

Standard Flat Cut Book-Match V1

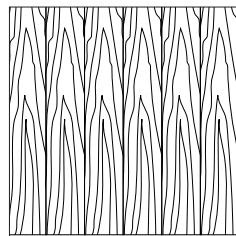

Flat Cut Slip-Match V2

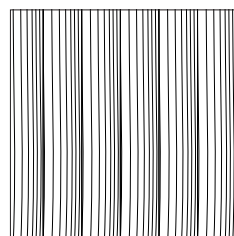

Quarter Cut Slip-Match Add 5% V3

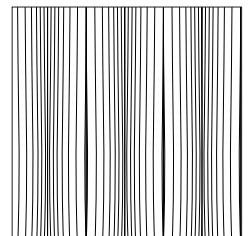

Quarter Cut Book-Match Add 5% V4

P-LAM

Wood grain plastic laminate surfaces are available on table tops with Self and Taper edges.

Nienkämper has pre-selected a number of standard wood grain plastic laminates that represent a cross section of both color and species. Simply include the order code with the model number to make these selections. Alternatively wood grain plastic laminates selected outside of Nienkämper's standard selection can be made by specifying the manufacturer as well as the description and model number of the laminate at the time of order.

Wood Edging

These tops are manufactured with a solid wood edge that is applied prior to the laminate top surface. This method conceals the thickness of the wood edge, while providing the durability required. Wood edges are selected that most closely resemble both the species and the color of the laminate chosen.

Laminate Edging on Taper and Self edge tops. Edging will match the top surface and is applied prior to the surface laminate. By applying the laminate in this way the seam is positioned horizontally, is much less conspicuous as well as more durable.

Translucent Edging on Taper and Self edge tops is applied after the surface laminate. The translucent edge is very durable. Clear translucent edge provides a good match with most white colored laminates, while silver translucent edge provides a metallic look and contrast to colored plastic laminates.

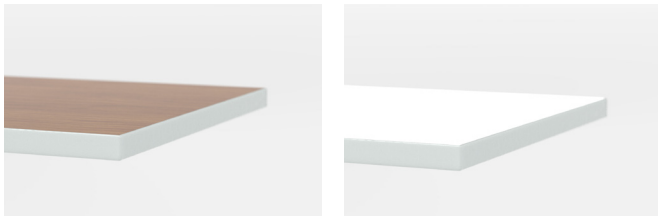

Wood Grain Plastic Laminate Surfaces	Order Code	Manufacturer #	Finish
Champagne Sagawood	WL1	Nevamar WM8349T	Textured
Hardrock Maple	WL2	Pionite WM791-SD	Textured/Suede
Amber Curly Maple	WL3	Pionite WM221-SD	Textured/Suede
Anagre	WL4	Pionite WX041-SD	Textured/Suede
Monticello Maple	WL5	Wilsonart 7925-38	Fine Velvet Texture
Millwork Cherry	WL7	Pionite WC431PV	PV-Polished Velvet
Figured Anagre	WL8	Formica7284-58	Matte
Huntington Maple	WL9	Wilsonart 7929-38	Fine Velvet Texture
Wild Cherry	WL10	Formica 5904.43	Artisan
Amber Cherry	WL11	Wilsonart 7919.38	Fine Velvet Texture
Figured Mahogany	WL12	Wilsonart 7040A-60	Matte
Fusion Maple	WL13	Wilsonart 7909-78	Fine Grain
New Age Oak	WL14	Wilsonart 7938-78	Fine Grain
Natural Pear	WL15	Wilsonart 7061-78	Fine Grain
Tuscan Walnut	WL16	Wilsonart 7921-78	Fine Grain
Nepal Teak	WL17	Wilsonart 7209-78	Fine Grain
Wild Cherry	WL18	Wilsonart 7054-78	Fine Grani
River Cherry	WL19	Wilsonart 7937-78	Fine Grain
Montana Walnut	WL20	Wilsonart 7110-78	Fine Grain
Sanara	WL21	Wilsonart 7932-78	Fine Grain
Windsor Mahogany	WL22	Wilsonart 7039-78	Fine Grain
Williamsburg Cherry	WL23	Wilsonart 7936-78	Fine Grain
Florence Walnut	WL25	Wilsonart 7993-78	Fine Grain
Skyline Walnut	WL26	Wilsonart 7964K-12	Soft Grain
Sterling Ash	WL27	Wilsonart 7995-78	Fine Grain

To specify the wood grain laminate required simply add the Order Code WL_ to the model number of the product.

Wood grain laminate samples are available from your local sales representative or by calling Nienkämper's customer service department at 1-800-668-9318.

COLOURED P-LAM

Both Taper and Self edge profiles are available with a colored laminate top.

Laminate Edging on Taper and Self edge tops. Edging will match the top surface and is applied prior to the surface laminate. By applying the laminate in this way the seam is positioned horizontally, is much less conspicuous as well as more durable.

Wood Edging on Taper and Self Edge tops is applied prior to the laminate. By applying the wood edge in this way the thickness of the wood edge is concealed, while providing the durability required. Wood species and finishes for edging, can be selected from page 5.

Translucent Edging on Taper and Self edge tops is applied after the surface laminate. The translucent edge is very durable. Clear translucent edge provides a good match with most white colored laminates, while silver translucent edge provides a metallic look and contrast to colored plastic laminates.

For laminates specified outside of Nienkämper’s standard selection, specify the manufacturer as well as the description and model number of the laminate selected at time of order. Note upcharges may apply for non-standard P-Lam, please check with Customer Service at 1 800 668 9318.

Coloured Plastic Laminates Surface	Order Code	Manufacturer #	Finish
Grey (Nienkamper - Light Grey/Putty)	CL-01	Wilsonart 1500-60	Matte
Platinum Gray (Nienkamper - Medium Grey/Clay)	CL-02	Nevamar S6023T	Textured
Slate Grey (Nienkamper - Dark Grey)	CL-03	Wilsonart D91-60	Matte
Black	CL-04	Wilsonart 1595-60	Matte
Angel White	CL-05	Pionite SW-826SD	Textured Suede
Frosty White	CL-06	Wilsonart 1573-60	Matte
White (for writable surfaces)	CL-07	Formica 949-90	Gloss

Add the order code behind the edge profile when specifying.

NIENKAMPER COLOURED “FINGERPRINT RESISTANCE” P-LAM

Fingerprint Resistance Plastic Laminate is an innovative material created for interior design applications and is suitable for both vertical and horizontal interior applications on our nienkamper furniture.

The external surface of Fingerprint Resistance Plastic Laminate involves the use of nanotechnology made possible by next generation acrylic resins.

The unique composition offers extraordinary features coupled with a unique user experience. These include an ultra matt surface (eliminating glare), an ultra sofa feel, an anti-fingerprint surface, thermal healing of micro-scratches, increased durability as well as anti-bacterial and mold-resistant properties.

Edgeband with matching color to the Fingerprint Resistance Plastic Laminate is only available on taper edge. For 1” thick top with self edge, same Fingerprint Resistance Plastic Laminate can be specified or it can be in clear/silver translucent edge.

There is a 10% upcharge on our standard plastic laminate pricing for Fingerprint Resistance Plastic Laminate.

Colored "Fingerprint Resistance" Plastic Laminate Surface	Order Code	Finish
Black	RL-01	Matte
Gray	RL-02	Matte
Pure White	RL-03	Matte
Sand	RL-04	Matte
Bronze	RL-05	Matte

Edgeband to Match with Colored "Fingerprint Resistance" Plastic Laminate	Order Code
Black	RE-01
Gray	RE-02
Pure White	RE-03
Sand	RE-04
Bronze	RE-05

VOX® FOLDING TABLE
RECTANGLE SHAPE - TUBULAR BASES



Rectangle shape - Tubular Bases

¾" thick top, 28½" H

¾" thick 16 degree
Taper Edge (TE-16)



¾" thick
Self Edge (SE)



Polished Chrome Base



Black Powder Coat Base

L" x D"	Sugg Seat Capacity	Top Finish	Top Sections	Model Number	List Price
80 x 36	4-6	Veneer	2	57603/2	6,220
80 x 36	4-6	Laminate	2	57603/5	5,275
84 x 36	6-8	Veneer	2	57604/2	6,350
84 x 36	6-8	Laminate	2	57604/5	5,370
96 x 36	6-8	Veneer	2	57605/2	6,825
96 x 36	6-8	Laminate	2	57605/5	5,850
78 x 42	4-6	Veneer	2	57606/2	6,585
78 x 42	4-6	Laminate	2	57606/5	5,505
84 x 42	6-8	Veneer	2	57607/2	6,625
84 x 42	6-8	Laminate	2	57607/5	5,610
96 x 42	6-8	Veneer	2	57608/2	7,175
96 x 42	6-8	Laminate	2	57608/5	6,075
111 x 42	6-8	Veneer	2	57609/2	7,525
111 x 42	6-8	Laminate	2	57609/5	6,225
120 x 42	6-8	Veneer	2	57610/2	7,830
120 x 42	6-8	Laminate	2	57610/5	6,480

L" x D"	Sugg Seat Capacity	Top Finish	Top Sections	Model Number	List Price
80 x 36	4-6	Veneer	2	57643/2	5,935
80 x 36	4-6	Laminate	2	57643/5	5,005
84 x 36	6-8	Veneer	2	57644/2	6,080
84 x 36	6-8	Laminate	2	57644/5	5,085
96 x 36	6-8	Veneer	2	57645/2	6,240
96 x 36	6-8	Laminate	2	57645/5	5,250
78 x 42	4-6	Veneer	2	57646/2	6,305
78 x 42	4-6	Laminate	2	57646/5	5,220
84 x 42	6-8	Veneer	2	57647/2	6,345
84 x 42	6-8	Laminate	2	57647/5	5,340
96 x 42	6-8	Veneer	2	57648/2	6,825
96 x 42	6-8	Laminate	2	57648/5	5,730
111 x 42	6-8	Veneer	2	57649/2	7,175
111 x 42	6-8	Laminate	2	57649/5	5,880
120 x 42	6-8	Veneer	2	57650/2	7,485
120 x 42	6-8	Laminate	2	57650/5	6,135

VOX® FOLDING TABLE
RECTANGLE SHAPE - SOLID BASES



Rectangle shape - Solid Bases

1" thick top, 28¾" H

1" thick 16 degree
Taper Edge (TE-16)



1" thick
Self Edge (SE)

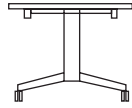

Polished Chrome Base



Black Powder Coat Base

L"	x	D"	Sugg Seat Capacity	Top Finish	Top Sections	Model Number	List Price
113	42	6-8	Veneer	2	57612/2	8,525	
113	42	6-8	Laminate	2	57612/5	7,380	
113	48	6-8	Veneer	2	57613/2	9,035	
113	48	6-8	Laminate	2	57613/5	7,645	
120	42	6-8	Veneer	2	57615/2	8,755	
120	42	6-8	Laminate	2	57615/5	7,470	
120	48	8-10	Veneer	2	57616/2	9,240	
120	48	8-10	Laminate	2	57616/5	7,720	

L"	x	D"	Sugg Seat Capacity	Top Finish	Top Sections	Model Number	List Price
113	42	6-8	Veneer	2	57652/2	7,580	
113	42	6-8	Laminate	2	57652/5	6,440	
113	48	6-8	Veneer	2	57653/2	8,085	
113	48	6-8	Laminate	2	57653/5	6,695	
120	42	6-8	Veneer	2	57655/2	7,810	
120	42	6-8	Laminate	2	57655/5	6,520	
120	48	8-10	Veneer	2	57656/2	8,290	
120	48	8-10	Laminate	2	57656/5	6,780	

VOX® FOLDING TABLE
RECTANGLE SHAPE WITH SOFT CORNERS - TUBULAR BASES



Rectangle shape with soft corners (4" radius corner) - Tubular Bases

¾" thick top, 28½" H

¾" thick 16 degree
Taper Edge (TE-16)



¾" thick
Self Edge (SE)

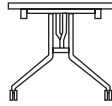

Polished Chrome Base



Black Powder Coat Base

L" x D"	Sugg Seat Capacity	Top Finish	Top Sections	Model Number	List Price
80 x 36	4-6	Veneer	2	57623/2	6,520
80 x 36	4-6	Laminate	2	57623/5	5,550
84 x 36	6-8	Veneer	2	57624/2	6,675
84 x 36	6-8	Laminate	2	57624/5	5,635
96 x 36	6-8	Veneer	2	57625/2	7,170
96 x 36	6-8	Laminate	2	57625/5	6,135
78 x 42	4-6	Veneer	2	57626/2	6,915
78 x 42	4-6	Laminate	2	57626/5	5,775
84 x 42	6-8	Veneer	2	57627/2	6,960
84 x 42	6-8	Laminate	2	57627/5	5,900
96 x 42	6-8	Veneer	2	57628/2	7,535
96 x 42	6-8	Laminate	2	57628/5	6,380
111 x 42	6-8	Veneer	2	57629/2	7,905
111 x 42	6-8	Laminate	2	57629/5	6,530
120 x 42	6-8	Veneer	2	57630/2	8,225
120 x 42	6-8	Laminate	2	57630/5	6,810

L" x D"	Sugg Seat Capacity	Top Finish	Top Sections	Model Number	List Price
80 x 36	4-6	Veneer	2	57663/2	6,240
80 x 36	4-6	Laminate	2	57663/5	5,250
84 x 36	6-8	Veneer	2	57664/2	6,390
84 x 36	6-8	Laminate	2	57664/5	5,350
96 x 36	6-8	Veneer	2	57665/2	6,545
96 x 36	6-8	Laminate	2	57665/5	5,520
78 x 42	4-6	Veneer	2	57666/2	6,625
78 x 42	4-6	Laminate	2	57666/5	5,480
84 x 42	6-8	Veneer	2	57667/2	6,670
84 x 42	6-8	Laminate	2	57667/5	5,600
96 x 42	6-8	Veneer	2	57668/2	7,170
96 x 42	6-8	Laminate	2	57668/5	6,015
111 x 42	6-8	Veneer	2	57669/2	7,535
111 x 42	6-8	Laminate	2	57669/5	6,165
120 x 42	6-8	Veneer	2	57670/2	7,860
120 x 42	6-8	Laminate	2	57670/5	6,450

VOX® FOLDING TABLE
RECTANGLE SHAPE WITH SOFT CORNERS - SOLID BASES



Rectangle shape with soft corners (4" radius corner) - Solid Bases

1" thick top, 28¾" H

1" thick 16 degree
Taper Edge (TE-16)



1" thick
Self Edge (SE)

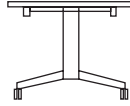

 Polished Chrome Base

 Black Powder Coat Base

L" x D"	Sugg Seat Capacity	Top Finish	Top Sections	Model Number	List Price
113 x 42	6-8	Veneer	2	57632/2	8,955
113 x 42	6-8	Laminate	2	57632/5	7,755
113 x 48	6-8	Veneer	2	57633/2	9,490
113 x 48	6-8	Laminate	2	57633/5	8,030
120 x 42	6-8	Veneer	2	57635/2	9,195
120 x 42	6-8	Laminate	2	57635/5	7,850
120 x 48	8-10	Veneer	2	57636/2	9,705
120 x 48	8-10	Laminate	2	57636/5	8,110

L" x D"	Sugg Seat Capacity	Top Finish	Top Sections	Model Number	List Price
113 x 42	6-8	Veneer	2	57672/2	7,960
113 x 42	6-8	Laminate	2	57672/5	6,765
113 x 48	6-8	Veneer	2	57673/2	8,485
113 x 48	6-8	Laminate	2	57673/5	7,035
120 x 42	6-8	Veneer	2	57675/2	8,200
120 x 42	6-8	Laminate	2	57675/5	6,850
120 x 48	8-10	Veneer	2	57676/2	8,705
120 x 48	8-10	Laminate	2	57676/5	7,120

FORUMS

M & N SERIES FORUM

M & N Series Forum are available in a wide range of configurations for power, data and audio/video requirement. Configure your require M & N Series Forum on our web site at this link www.nienkamper.com/vfc



SIMPLE POP UP FORUM - Single sided (Surface mounted)

Pre-configured SIMPLE Pop Up Forum			List Price				
Model # 85190	pre-wired power (2 ports)	<table border="1"> <tr> <td>1P</td> <td>1P</td> </tr> </table> <p>cutout dimension: 5"W x 4"D 2 x pre-wired power with 10ft cord</p>	1P	1P	\$500		
1P	1P						
Model # 85191	pre-wired power (3 ports)	<table border="1"> <tr> <td>1P</td> <td>1P</td> <td>1P</td> </tr> </table> <p>cutout dimension: 6 1/2"W x 4"D 3 x pre-wired power with 10ft cord</p>	1P	1P	1P	\$510	
1P	1P	1P					
Model # 85192	pre-wired power (3 ports)	<table border="1"> <tr> <td>1P</td> <td>1P</td> <td>A0</td> </tr> </table> <p>cutout dimension: 6 1/2"W x 4"D 2 x pre-wired power with 10ft cord 1 x AMP CAT5E data with 9ft cord</p>	1P	1P	A0	\$585	
1P	1P	A0					
Model # 85193	pre-wired power (3 ports)	<table border="1"> <tr> <td>1P</td> <td>1P</td> <td>A5</td> </tr> </table> <p>cutout dimension: 6 1/2"W x 4"D 2 x pre-wired power with 10ft cord 1 x Siemon CAT6 data with 10ft cord</p>	1P	1P	A5	\$620	
1P	1P	A5					
Model # 85197	pre-wired power (4 ports)	<table border="1"> <tr> <td>1P</td> <td>1P</td> <td>O</td> </tr> </table> <p>cutout dimension: 6 1/2"W x 4"D 2 x pre-wired power with 10ft cord 1 x open port / data adapter to fit in client's own data fitting and cord</p>	1P	1P	O	\$510	
1P	1P	O					
Model # 85194	pre-wired power (3 ports)	<table border="1"> <tr> <td>1P</td> <td>1P</td> <td>2U</td> </tr> </table> <p>cutout dimension: 6 1/2"W x 4"D 2 x pre-wired power with 10ft cord 2 x USB charger (stacked)</p>	1P	1P	2U	\$590	
1P	1P	2U					
Model # 85195	pre-wired power (4 ports)	<table border="1"> <tr> <td>1P</td> <td>1P</td> <td>A0</td> <td>A0</td> </tr> </table> <p>cutout dimension: 8"W x 4"D 2 x pre-wired power with 10ft cord 2 x AMP CAT5E data with 9ft cord</p>	1P	1P	A0	A0	\$640
1P	1P	A0	A0				

Model # 85196	pre-wired power (4 ports)	<table border="1"> <tr> <td>1P</td> <td>1P</td> <td>A5</td> <td>A5</td> </tr> </table> <p>cutout dimension: 8"W x 4"D 2 x pre-wired power with 10ft cord 2 x Siemon CAT6 data with 10ft cord</p>	1P	1P	A5	A5	\$710		
1P	1P	A5	A5						
Model # 85198	pre-wired power (4 ports)	<table border="1"> <tr> <td>1P</td> <td>1P</td> <td>O</td> <td>O</td> </tr> </table> <p>cutout dimension: 8"W x 4"D 2 x pre-wired power with 10ft cord 2 x open port / data adapter to fit in client's own data fitting and cord</p>	1P	1P	O	O	\$535		
1P	1P	O	O						
Model # 85199	pre-wired power (4 ports)	<table border="1"> <tr> <td>1P</td> <td>1P</td> <td>2U</td> <td>HD</td> </tr> </table> <p>cutout dimension: 8"W x 4"D 2 x pre-wired power with 10ft cord 2 x USB charger (stacked) 1 x HDMI coupler with 18" cord</p>	1P	1P	2U	HD	\$725		
1P	1P	2U	HD						
Model # 85200	pre-wired power (4 ports)	<table border="1"> <tr> <td>1P</td> <td>1P</td> <td>2U</td> <td>O</td> </tr> </table> <p>cutout dimension: 8"W x 4"D 2 x pre-wired power with 10ft cord 2 x USB charger (stacked) 1 x open port / data adapter to fit in client's own data fitting and cord</p>	1P	1P	2U	O	\$635		
1P	1P	2U	O						
Model # 85201	pre-wired power (6 ports)	<table border="1"> <tr> <td>1P</td> <td>1P</td> <td>2U</td> <td>HD</td> <td>A0</td> <td>A0</td> </tr> </table> <p>cutout dimension: 11"W x 4"D 2 x pre-wired power with 10ft cord 2 x USB charger (stacked) 1 x HDMI coupler with 18" cord 2 x AMP CAT5E data with 9ft cord</p>	1P	1P	2U	HD	A0	A0	\$910
1P	1P	2U	HD	A0	A0				
Model # 85202	pre-wired power (6 ports)	<table border="1"> <tr> <td>1P</td> <td>1P</td> <td>2U</td> <td>HD</td> <td>A5</td> <td>A5</td> </tr> </table> <p>cutout dimension: 11"W x 4"D 2 x pre-wired power with 10ft cord 2 x USB charger (stacked) 1 x HDMI coupler with 18" cord 2 x Siemon CAT6 data with 10ft cord</p>	1P	1P	2U	HD	A5	A5	\$985
1P	1P	2U	HD	A5	A5				
Model # 85203	pre-wired power (6 ports)	<table border="1"> <tr> <td>1P</td> <td>1P</td> <td>2U</td> <td>HD</td> <td>O</td> <td>O</td> </tr> </table> <p>cutout dimension: 11"W x 4"D 2 x pre-wired power with 10ft cord 2 x USB charger (stacked) 1 x HDMI coupler with 18" cord 2 x open port/ data adapter to fit in client's own data fitting and cord</p>	1P	1P	2U	HD	O	O	\$790
1P	1P	2U	HD	O	O				

FORUMS - SIMPLE POP UP FORUM



SIMPLE POP UP FORUM – DOUBLE SIDED (SURFACE MOUNTED)

Pre-configured SIMPLE Pop Up Forum

List Price

Model # 85205 pre-wired power
(each side - 2 ports)



cutout dimension: 5"W x 7-11/16"D
Side A: 2 x pre-wired power with 10ft cord
Side B: 2 x pre-wired power with 10ft cord
(Provides a total of 4 x pre wired power)

\$1,020

Model # 85206 pre-wired power
(each side - 3 ports)

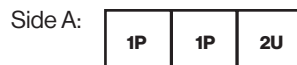

cutout dimension: 6-1/2"W x 7-11/16"D
Side A: 2 x pre-wired power with 10ft cord
2 x USB Charger (stacked)
Side B: 2 x pre-wired power with 10ft cord
2 x USB Charger (stacked)
(Provides a total of 4 x pre wired power & 4 x USB Charger)

\$1,280

Model # 85208 pre-wired power (each side - 4 ports) Side A:

1P	1P	A5	A5
----	----	----	----

 \$1,450



cutout dimension: 8"W x 7-11/16"D
 Side A: 2 x pre-wired power with 10ft cord
 2 x Siemon CAT6 data with 10ft cord
 Side B: 2 x pre-wired power with 10ft cord
 2 x Siemon CAT6 data with 10ft cord
 (Provides a total of 4 x pre wired power & 4 x Siemon CAT6 data)

Model # 85209 pre-wired power (each side - 4 ports) Side A:

1P	1P	O	O
----	----	---	---

 \$1,050



cutout dimension: 8"W x 7-11/16"D
 Side A: 2 x pre-wired power with 10ft cord
 2 x open port/data adapter to fit in client's own data fitting and cord
 Side B: 2 x pre-wired power with 10ft cord
 2 x open port/data adapter to fit in client's own data fitting and cord
 (Provides a total of 4 x pre wired power & 4 x open ports)

Model # 85210 pre-wired power (each side - 4 ports) Side A:

1P	1P	2U	O
----	----	----	---

 \$1,295



cutout dimension: 8"W x 7-11/16"D
 Side A: 2 x pre-wired power with 10ft cord,
 2 x USB Charger (stacked)
 1 x open port/ data adapter to fit in client's own data fitting and cord
 Side B: 2 x pre-wired power with 10ft cord,
 2 x USB Charger (stacked)
 1 x open port/ data adapter to fit in client's own data fitting and cord
 (Provides a total of 4 x pre wired power, 4 x USB Charger & 2 x open ports)

FORUMS - SIMPLE POP UP FORUM

- Note:
- Finish is standard in clear anodized aluminum.
 - For power cord with 6ft long, please add a letter "B" at the end of model #.
 - Site-wired / hard-wired power with 72" metallic shielded cable is available with an upcharge of \$60 list per 2 power. Please add a letter "H" at the end of model #.

Each open port selected will be supplied with one set of data adapter kit contains 2 "AA", 2 "BB", 2 "CC", 2 "DD", 2 "EE", 2 "FF", 1 "GG" and 1 "HH". adapter. The data adapter can accommodate the following data fitting from manufacturer:

Adapter "AA"

Systimax/CommScope
Uniprise/CommScope

Adapter "BB"

L-Com Keystone Modular
Tyco SL/110 Connect Series Modular Jacks
Siemon Keystone Style
Allen Tel Versa Tap Series
Leviton Quick Port® Series
Nordx Keystone Style
Tyco SL Conpler Series

Adapter "CC"

Krone 6000 Series/ADC
Hubbell Xcelerator™ Keystone Series

Adapter "DD"

blank

Adapter "EE"

Ortronics TracJack Series

Adapter "FF"

Panduit Mini-Com Series

Adapter "GG"

microphone jack / 3pin XLR, solder type only

Adapter "HH"

Adapter "HH" - video monitor jack / DB-15, panel mount solder type.

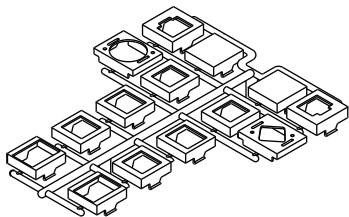

- Snap in fitting adapters are also provide for 3-pin XLR microphone jack (solder type only) and DB-15 video monitor jack (panel mount solder style only)

- Snap in fitting adapters are also provide for 3-pin XLR microphone jack (solder type only) and DB-15 video monitor jack (panel mount solder style only)

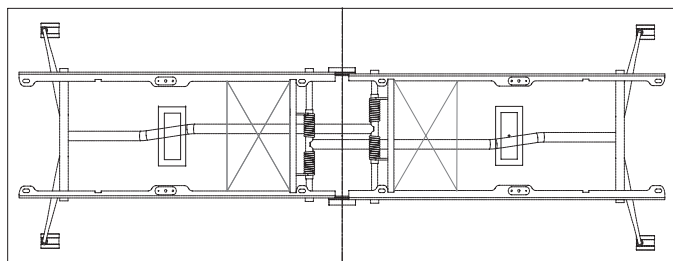

Positioning of Simple Pop Up Forum (Single Sided - 4 Ports) on Vox® Folding Table with Tubular bases.

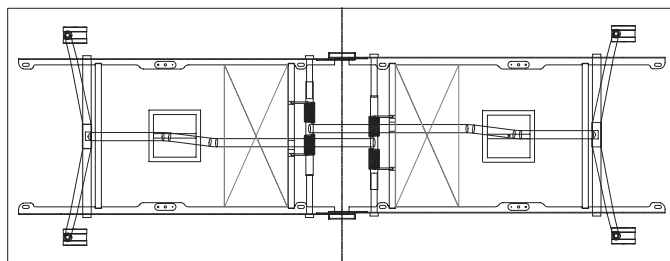

Positioning of Simple Pop Up Forum (Double Sided - Each Side with 4 Ports) on Vox® Folding Table with Solid bases.

FORUMS - SIMPLE POP UP FORUM

List Price

Client can configure their own SIMPLE Pop Up Forum by selecting a base model and require elements.

Base Model For Simple Pop Up Forum

(4 Ports)

Model #: CX4P - _____

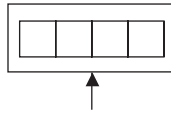

\$435

Base Model For Simple Pop Up Forum

(6 Ports)

Model #: CX6P - _____

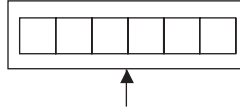

\$490

Base Model For Simple Pop Up Forum – Double Sided

(Each Side – 4 Ports)

Model #: CX8PD-A _____ (Side A)

CX8PD-B _____ (Side B)

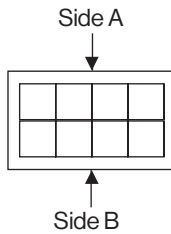

\$930

Base Model For Simple Pop Up Forum – Side By Side

(Each Side – 4 Ports)





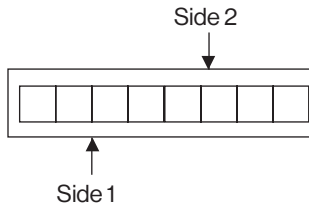







Model #: CX8PS-1 _____ (Side 1)

CX8PS-2 _____ (Side 2)



\$970

Select the elements as per below:

	1P - 1 power receptacle with 10' white cord	\$105
	1P-SW - 1 power receptacle hard wired with a 6' whip	\$125
	A0- AMP CAT5E data fitting with 9' connector cable	\$120
	A5 - SIEMON CAT 6 data fitting with 10' connector cable	\$140
	C - Audio- 3.5mm Mini stereo Jack with 10' cord	\$65
	H - USB port 3.0 with 10ft cord	\$95
	2U - Stacked USB charger	\$130
	G - DB15HD, VGA connector, 10' cord	\$155
	HD - HDMI Coupler with 18" cord	\$155
	B - Blank plate	\$40
	O - Open port, for client's own data fitting. Each port selected will be supplied with one set of data adapter kit (see page 43)	\$40
	L - Belay 1" dia. hole opening rubber strain relief pass through cords	\$40

GROMMETS & CABLE CONDUITS

	Model Number	List Price	Product Description
VOX® PLASTIC GROMMET 	70286 (black)	\$55	This large rectangular plastic grommet has capacity for the most demanding wire management needs. When not in use the hinged cover swings up to close the grommet. Overall dimension is 4" L x 2" W (interior clearance - 3 ⁵ / ₈ " L x 1 ⁵ / ₈ " W). Available in three colours to coordinate with a variety of top finishes.
	70287 (cool grey)	\$55	
	70288 (warm grey)	\$55	

VOX® CABLE CONDUIT

Vox® Expandable Cable Conduit

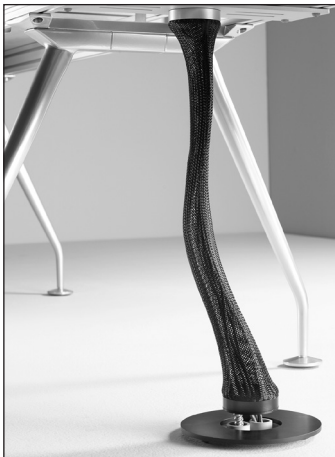

55024-B black	\$940
55024-S silver	\$940
55024-C clear	\$940

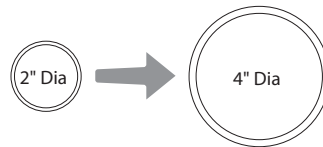

The Vox® Expandable Cable Conduit is made of woven, flexible plastic wire. Its unique properties allow it to expand and contract to allow for different cable capacities.

A "U" bracket at the top attaches to the support rail. An 8" diameter counter weight is incorporated at the base which can be positioned to accommodate core drills or receptacle positions. Inside hole diameter is 3.5".

Cable capacity range is from two inches to four inches.

Shipped with extra length, the Vox expandable cable conduit can easily be shortened on site if required.

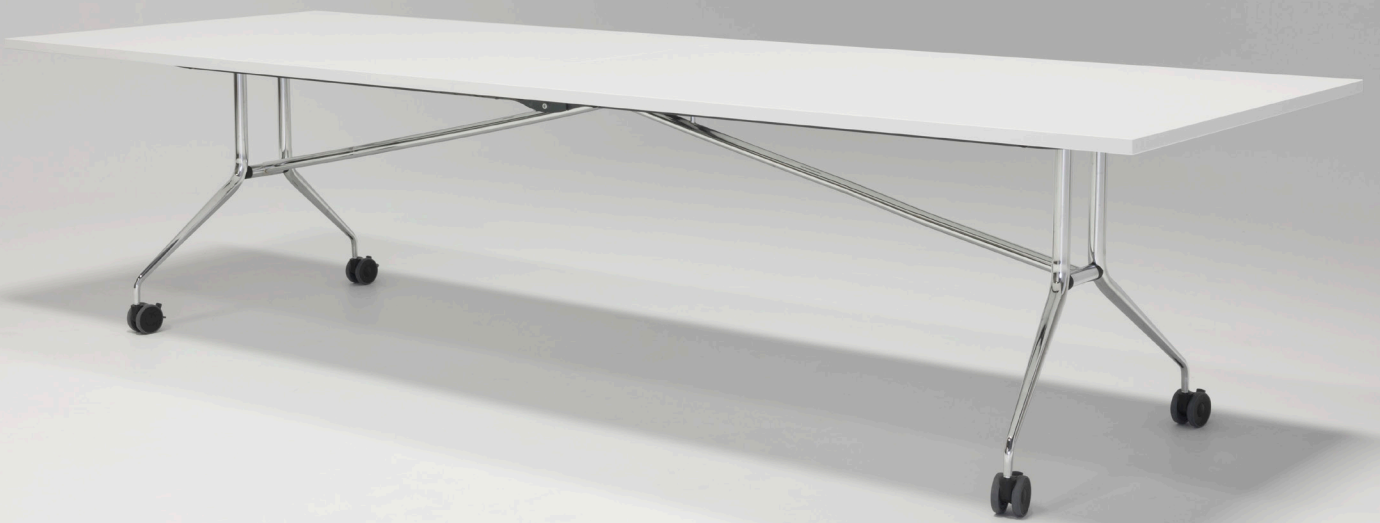

nienkämper

