

GATEWAY™

busk + heretzog



nienkämper



FEATURES & OPTIONS

The Gateway™ Collection is comprised of 3 major elements that work in conjunction to provide smart solutions to multimedia presentation, video conference and traditional office requirements.

Elements:

Gateway™ Media Wall Tables:

- Media Wall Tables are an excellent solution for areas that require highly interactive meeting capabilities.
- Media wall tables feature an integrated vista or round top with a media ready screen and stylish base.
- Three table heights are available: 22", 29" and 38".
- Three screen heights are available: 56", 63" and 72".
- Two screen widths are available: 48" and 58".
- Tables can be specified with a variety of power / data / video / audio solutions for singular and group requirements.
- Wiring runs concealed through base, screen and grommets.

Gateway™ Conference and Stand-Alone Tables:

- Gateway™ Conference and Stand Alone Tables are an excellent solution for boardrooms and lounges alike.
- Gateway™ conference table tops are available with a wide variety of top shapes, sizes and edges to meet your needs.
- Tops are available in all standard veneer and plastic laminate finishes.
- Gateway™ bases are available in mirror polished and five anodized finishes: clear, champagne, light bronze, bronze and black.
- Tables can be specified with a variety of power / data / video / audio solutions for singular and group requirements.
- Wiring runs concealed through base and grommets.

Gateway™ Upholstered Lounge Elements:

- Gateway™ upholstered lounge elements enable comfortable collaboration.
- Gateway™ upholstered lounge elements include linear and curved modular components which enable the customer to create their own solution.
- Element styles are bench, sofa and sofa with integrated privacy screen.
- Tables are available in 2 styles. Wave to compliment sofa or bench element or round. Fabric, vinyl and leather available for seating elements.
- Privacy screens can be contrasting or matching fabrics.



GATEWAY™ MEDIA WALL TABLES

Media Screen Options:

Dimensions: 2 widths: 48" & 58"
 48" wide screens accommodate a maximum monitor size of 46"
 58" wide screens accommodate a maximum monitor size of 60"
 3 heights: 56", 63", 72"

Fabrics: • All media screens are covered in fabric and are available in UV fabrics.
 • COM is also acceptable in most cases
 • Contact customer service for details.

Trim: Polish aluminum trim is standard; however, 5 anodized finishes (clear, champagne, light bronze, bronze, and black) are available. Trimless option is also available.

Accessories: • Media screens arrive on site with integrated brackets for customers to mount their desired TV mounting bracket.
 • Note: Flat screen monitors and mounts not included. For additional information on TV mounting bracket, see page 11.
 • Cables are concealed inside the screen and out through either the bottom of the screen, an external conduit wire manager or out through the V base. Large diameter polished leveler feet are standard.

Top Options:

Dimensions: 3 table heights are standard to Gateway™, 22" lounge height, 29" standard work height and 38" standing height.
 2 Table widths: 48" & 58" which depend on screen width
 Table lengths are available from 48" - 96" +
 Standard top thickness is 1.25"

Top Shape: Standard top shapes are Vista, Round, Rectangular, Soft Square, Half Ellipse
 Edges: 2" taper edge is standard self edge also available.

Material /Finishes: • Gateway™ table tops are available in all Nienkamper high quality veneers and finishes with grain lay up and options.
 • All standard plastic laminates are also available.

Connectivity Options:

Gateway™ Media Wall Tables are available with a range of single and multi-user connectivity devices to suit most technology and price point requirements.

The system can also be customized to suite customer specific equipment.

Refer to page 14-15 for more information on connectivity.



Base Features & Options:

Dimensions: Gateway™ Media tables have a common base size of 24" & 34" wide. See page 10 for dimension of its interior clearance.

Finishes: • Bases are standard with a mirror polished finish.
 • Bases are also available in all standard Nienkamper powder coat finishes.



GATEWAY™ MEDIA WALL TABLES

— US ONLY —

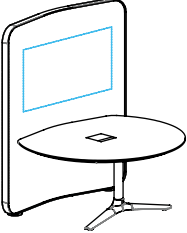
| | Model Number | Table Dimensions | Media Wall Dimensions | Top Finish | Fabric Yrd | List Price COM | UV 1 |
|--|----------------|----------------------|-----------------------|-----------------|------------|----------------|---------------|
| Table with Media Wall: 22" Lounge Height  | 42201/2 | 48"dia x 22"h | 48"w x 56"h | Veneer | 4 | 12,135 | 14,110 |
| | 42201/5 | 48"dia x 22"h | 48"w x 56"h | Laminate | 4 | 11,470 | 13,450 |
| | 42202/2 | 58"dia x 22"h | 58"w x 56"h | Veneer | 5 | 13,015 | 14,990 |
| | 42202/5 | 58"dia x 22"h | 58"w x 56"h | Laminate | 5 | 12,000 | 13,985 |

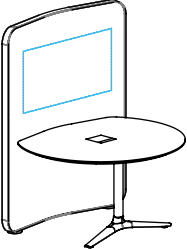
| | | | | | | | |
|--|----------------|----------------------|--------------------|-----------------|------------|---------------|---------------|
| Table with Media Wall: 29" Standard Work Height  | 42203/2 | 48"dia x 29"h | 48"w x 63"h | Veneer | 4 | 12,380 | 14,400 |
| | 42203/5 | 48"dia x 29"h | 48"w x 63"h | Laminate | 4 | 11,705 | 13,715 |
| | 42204/2 | 58"dia x 29"h | 58"w x 63"h | Veneer | 6.5 | 13,265 | 15,290 |
| | 42204/5 | 58"dia x 29"h | 58"w x 63"h | Laminate | 6.5 | 12,250 | 14,255 |

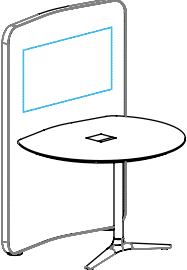
| | | | | | | | |
|--|----------------|----------------------|--------------------|-----------------|------------|---------------|---------------|
| Table with Media Wall: 38" Standing Height  | 42205/2 | 48"dia x 38"h | 48"w x 72"h | Veneer | 5 | 12,635 | 14,685 |
| | 42205/5 | 48"dia x 38"h | 48"w x 72"h | Laminate | 5 | 11,935 | 13,995 |
| | 42206/2 | 58"dia x 38"h | 58"w x 72"h | Veneer | 7.5 | 13,530 | 15,590 |
| | 42206/5 | 58"dia x 38"h | 58"w x 72"h | Laminate | 7.5 | 12,485 | 14,540 |

Connectivity devices are to be ordered separately and cost is not reflected in above pricing. Refer to page 14-15 for more information.
 Flat panel monitors and mounting brackets to be supplied by customer and are not included in above pricing.
 48" wide Gateway Media Wall accommodates a maximum monitor of 46".
 58" wide Gateway Media Wall accommodates a maximum monitor of 60".

GATEWAY™ MEDIA WALL TABLES

— US ONLY —

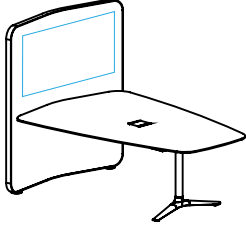
| | Model Number | Table Dimensions | Media Wall Dimensions | Top Finish | Fabric Yrd | List Price COM | UV 1 |
|---|----------------|---------------------------------------|-----------------------|-----------------|------------|----------------|---------------|
| Table with Media Wall: 29" Standard Work Height  | 42207/2 | 60"l x (21 3/4" - 45")w x 29"h | 48"w x 63"h | Veneer | 4 | 12,845 | 14,820 |
| | 42207/5 | 60"l x (21 3/4" - 45")w x 29"h | 48"w x 63"h | Laminate | 4 | 11,975 | 13,955 |
| | 42211/2 | 60"l x (32" - 55")w x 29"h | 58"w x 63"h | Veneer | 6.5 | 13,100 | 15,115 |
| | 42211/5 | 60"l x (32" - 55")w x 29"h | 58"w x 63"h | Laminate | 6.5 | 12,230 | 14,230 |
| | 42208/2 | 72"l x (21 3/4" - 45")w x 29"h | 48"w x 63"h | Veneer | 4 | 13,435 | 15,415 |
| | 42208/5 | 72"l x (21 3/4" - 45")w x 29"h | 48"w x 63"h | Laminate | 4 | 12,335 | 14,315 |
| | 42212/2 | 72"l x (32" - 55")w x 29"h | 58"w x 63"h | Veneer | 6.5 | 13,700 | 15,715 |
| | 42212/5 | 72"l x (32" - 55")w x 29"h | 58"w x 63"h | Laminate | 6.5 | 12,600 | 14,610 |
| | 42209/2 | 84"l x (21 3/4" - 45")w x 29"h | 48"w x 63"h | Veneer | 4 | 13,835 | 15,815 |
| | 42209/5 | 84"l x (21 3/4" - 45")w x 29"h | 48"w x 63"h | Laminate | 4 | 12,590 | 14,550 |
| | 42213/2 | 84"l x (32" - 55")w x 29"h | 58"w x 63"h | Veneer | 6.5 | 14,110 | 16,120 |
| | 42213/5 | 84"l x (32" - 55")w x 29"h | 58"w x 63"h | Laminate | 6.5 | 12,830 | 14,840 |

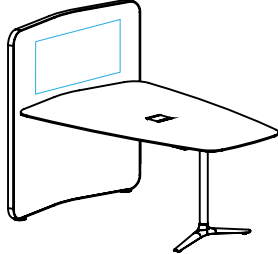
| | | | | | | | |
|---|----------------|---------------------------------------|--------------------|-----------------|------------|---------------|---------------|
| Table with Media Wall: 38" Standing Height  | 42214/2 | 60"l x (21 3/4" - 45")w x 38"h | 48"w x 72"h | Veneer | 5 | 13,365 | 15,415 |
| | 42214/5 | 60"l x (21 3/4" - 45")w x 38"h | 48"w x 72"h | Laminate | 5 | 12,460 | 14,515 |
| | 42217/2 | 60"l x (32" - 55")w x 38"h | 58"w x 72"h | Veneer | 7.5 | 13,630 | 15,715 |
| | 42217/5 | 60"l x (32" - 55")w x 38"h | 58"w x 72"h | Laminate | 7.5 | 12,695 | 14,805 |
| | 42215/2 | 72"l x (21 3/4" - 45")w x 38"h | 48"w x 72"h | Veneer | 5 | 13,980 | 16,025 |
| | 42215/5 | 72"l x (21 3/4" - 45")w x 38"h | 48"w x 72"h | Laminate | 5 | 12,835 | 14,885 |
| | 42218/2 | 72"l x (32" - 55")w x 38"h | 58"w x 72"h | Veneer | 7.5 | 14,255 | 16,350 |
| | 42218/5 | 72"l x (32" - 55")w x 38"h | 58"w x 72"h | Laminate | 7.5 | 13,085 | 15,180 |
| | 42216/2 | 84"l x (21 3/4" - 45")w x 38"h | 48"w x 72"h | Veneer | 5 | 14,390 | 16,445 |
| | 42216/5 | 84"l x (21 3/4" - 45")w x 38"h | 48"w x 72"h | Laminate | 5 | 13,075 | 15,135 |
| | 42219/2 | 84"l x (32" - 55")w x 38"h | 58"w x 72"h | Veneer | 7.5 | 14,675 | 16,770 |
| | 42219/5 | 84"l x (32" - 55")w x 38"h | 58"w x 72"h | Laminate | 7.5 | 13,335 | 15,435 |

Connectivity devices are to be ordered separately and cost is not reflected in above pricing. Refer to page 14-15 for more information.

Flat panel monitors and mounting brackets to be supplied by customer and are not included in above pricing.

48" wide Gateway Media Wall accommodates a maximum monitor of 46".

58" wide Gateway Media Wall accommodates a maximum monitor of 60".

GATEWAY™ MEDIA WALL TABLES SPECIFICATIONS

Gateway table with media screen
58" x 60"

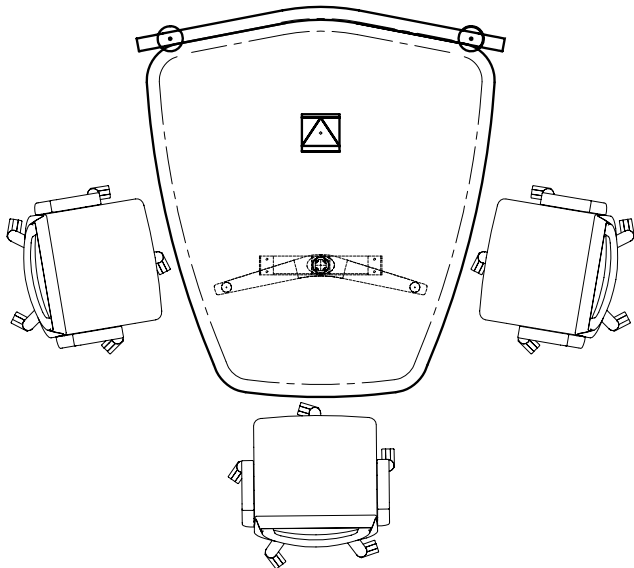

Gateway table with media screen
58" x 84"

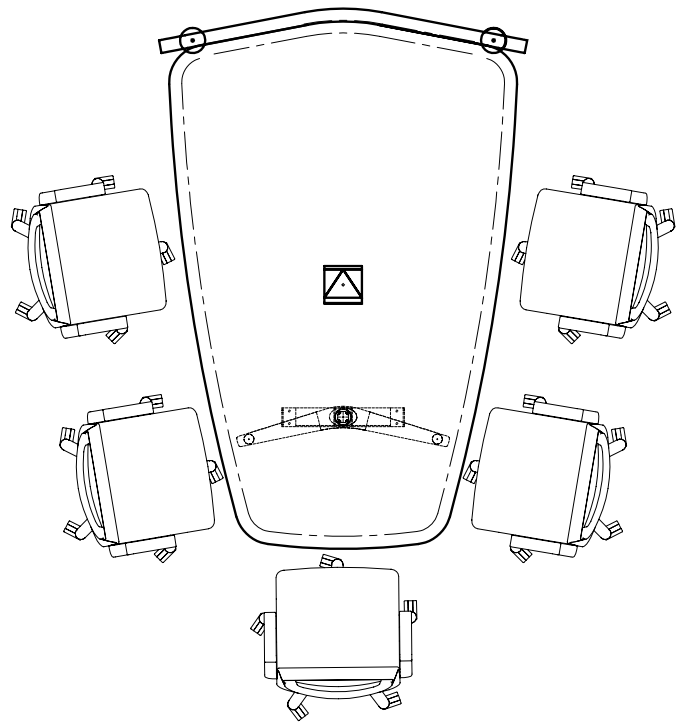

Connectivity devices are to be ordered separately and cost is not reflected in above pricing. Refer to page 14-15 for more information.

Flat panel monitors and mounting brackets to be supplied by customer and are not included in above pricing.

48" wide Gateway Media Wall accommodates a maximum monitor of 46".

58" wide Gateway Media Wall accommodates a maximum monitor of 60".

GATEWAY™ MEDIA WALL TABLES CONNECTIVITY

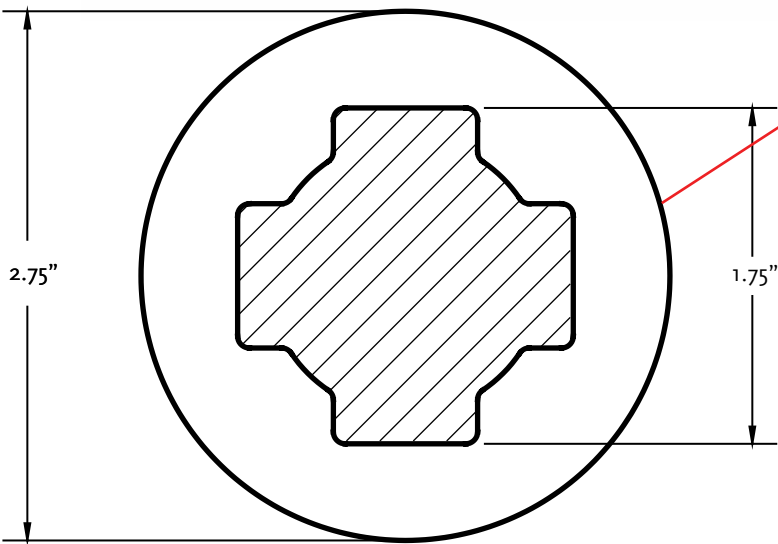
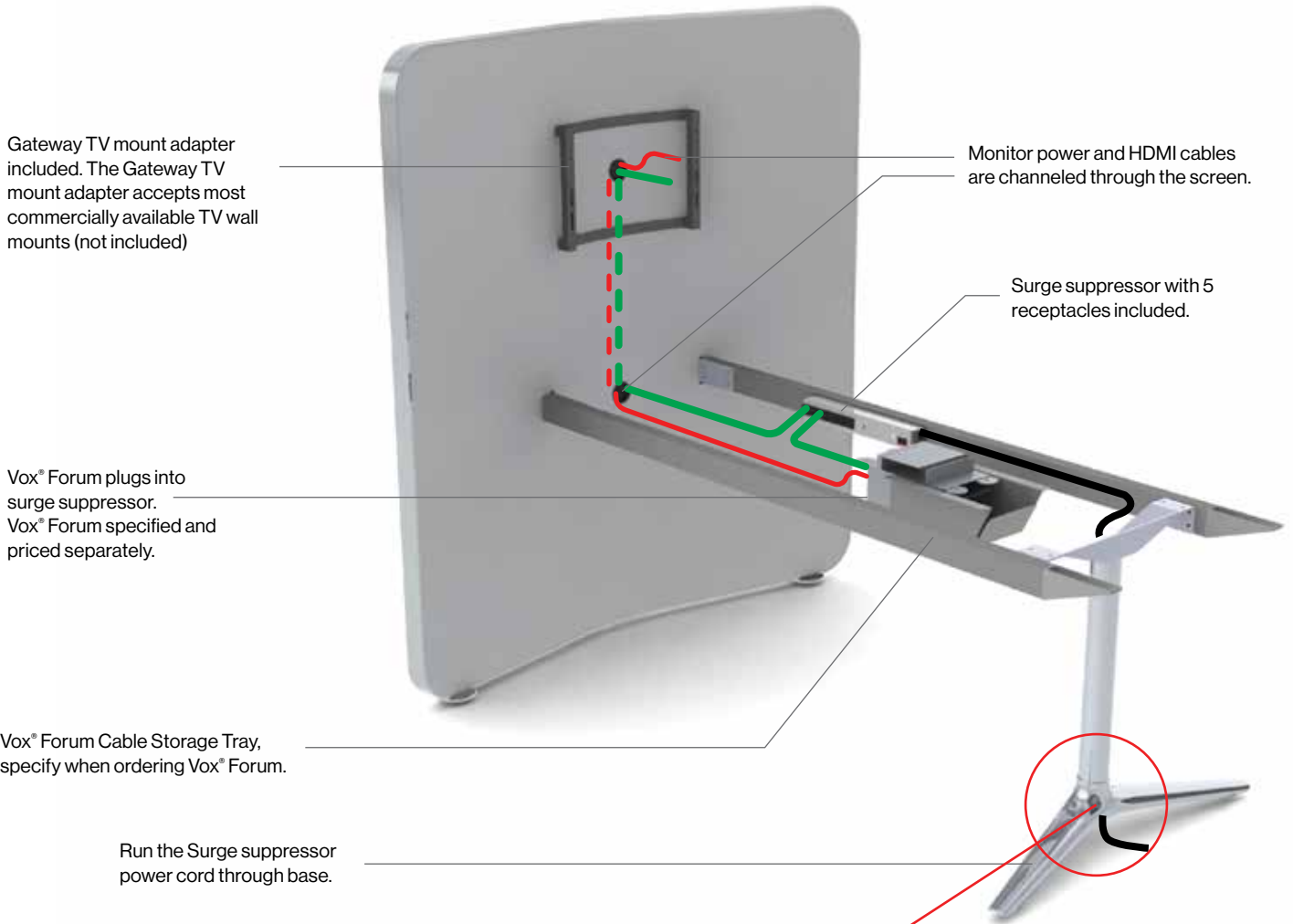

Cable access in base (full scale)

* Contact customer service for further details.

GATEWAY™ MEDIA WALL TABLES CONNECTIVITY

Optional cable access at back of panel needs to be specified when ordering. Standard Gateway media walls do not come with grommet in back of wall.

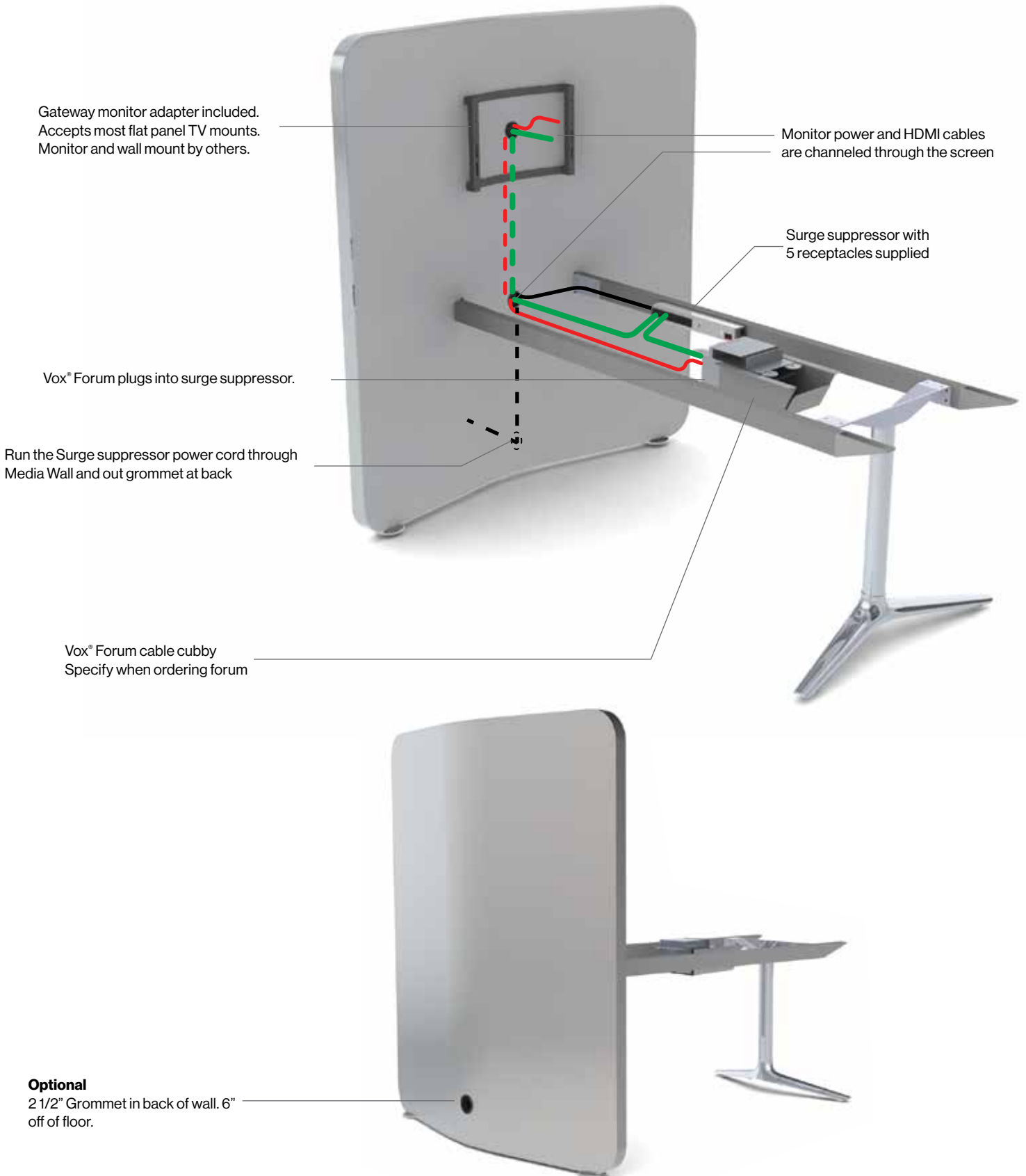

GATEWAY™ MEDIA WALL TABLES CONNECTIVITY

48" wide Gateway screens can accommodate television monitors from 32" to 46".

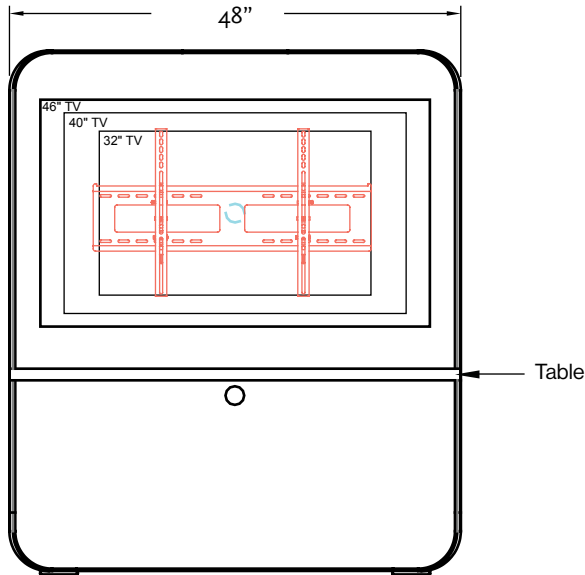

58" wide Gateway screens can accommodate television monitors from 40" to 60".

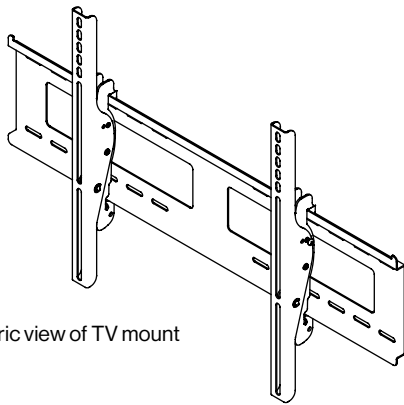
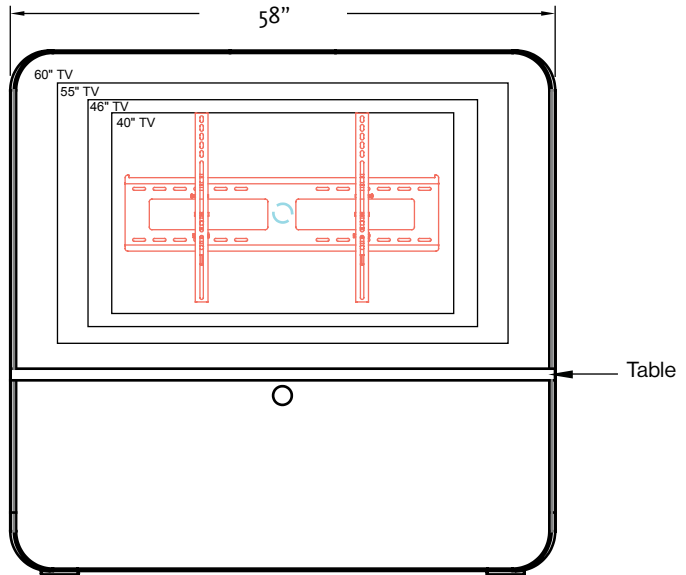

Isometric view of TV mount

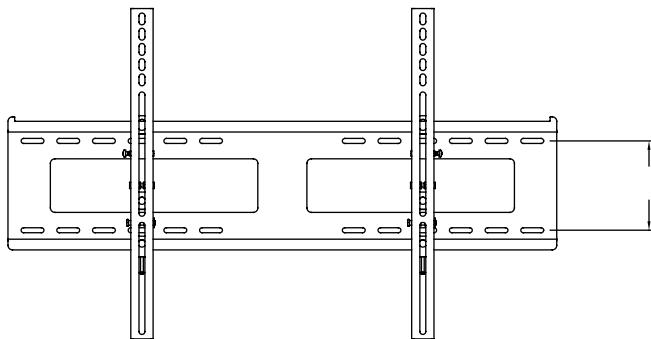

Elevation view of TV mount

Gateway screen accepts all manufacturers low profile
Flat or tilting mount with a mounting hole
Spacing distance from 2" to 8 3/4".

Low profile mounts approved for use with Gateway Screens
are listed below.

Atdec TH-3050-RW
TH-3060-UT
TH-3070 UTP

Rocketfish RF-TVMLPT03
RF-TVMLPT02

Sanus LT25
LL22
VLT35
VMPL50A

Sonax F-101-MTM
F-102-MTM
F-102-MPM
F-103-MPM
K-505-MPM
K-005-MPM
M-415-MPM
M-515-MPM

Please contact customer service if the flat panel mount
you have selected is not listed.

GATEWAY™ MEDIA WALL TABLES CONNECTIVITY

The Extron “Show Me” HDMI cables and VGA cables allows up to 6 users to share information from their tablet or laptop to a monitor.

To share information simply connect your laptop or tablet to the “Show Me” HDMI cable or VGA cable. Press the share button on the “Show Me” cable to display your desktop to the monitor. Images are displayed in High Definition with full Audio.

Collaboration sessions are safe and Secure. The hard-wired signal path protects sensitive content from remote monitoring.

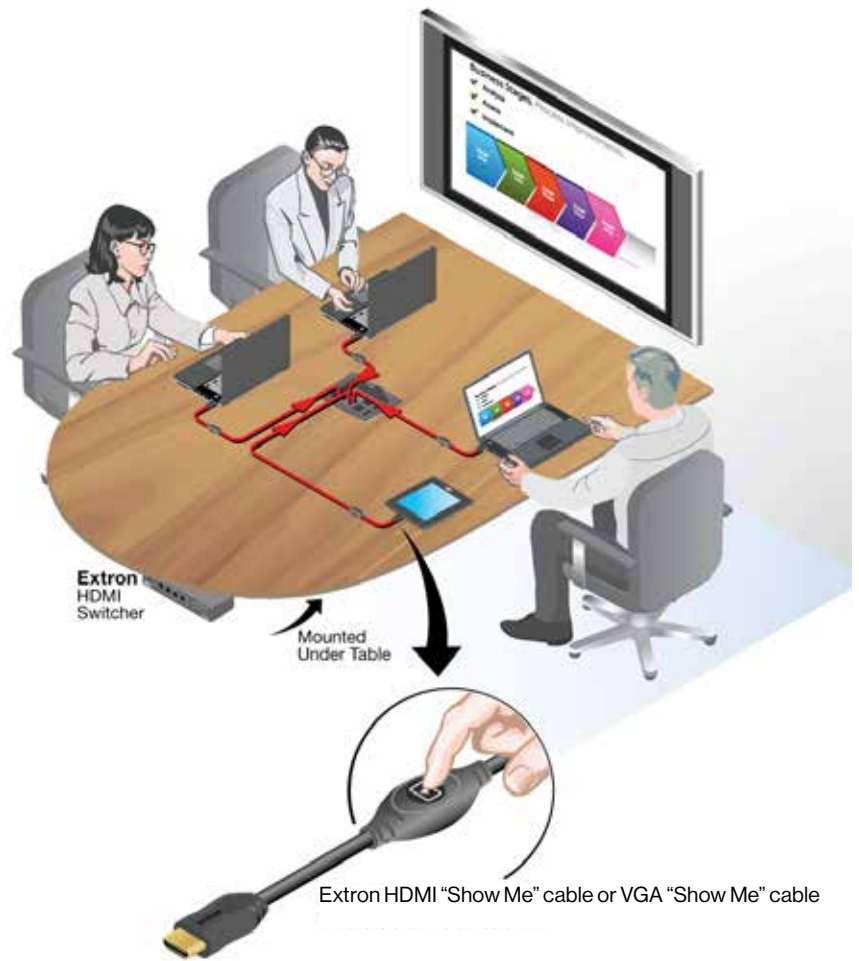

M Series Forum with HDMI “Show Me” cables only

GATEWAY™ MEDIA WALL TABLES CONNECTIVITY

Details of Vox® Forum with Extron “Show Me” HDMI cables only



Vox® Forum, M Series with HDMI “Show Me” cables only

M-1P, 7V, 10X

- 1 split plate w/ 4 holes at 1/2”dia
- 2 power receptacles
- 1 blank plate
- Surge suppressor
- Wire management U clips
- Cable storage

Also included:

- Teamwork HDMI “Show Me” cables (4 qty)
- Extron SW4 HDMI with EDID Minder switcher
- 12’ HDMI cable under table mounting shelf
- UTS 100 primary shelf

List Price \$4,270

Details of Vox® Forum with Extron “Show Me” HDMI and VGA cables only



Vox® Forum, M Series with HDMI & VGA “Show Me” cables

M-1P, 11X - 11X

- 2 power receptacles
- Double split plate each with 3 holds at 1/2” dia.
- Surge suppressor
- Wire management U clips
- Cable storage

Also included:

- Teamwork HDMI “Show Me” cables (4 qty)
- Teamwork VGA “Show Me” cables (2 qty)
- 3.5mm audio cables (2 qty)
- Extron MPS 601 media switcher
- 12’ HDMI cable under table mounting shelf
- UTS 100 primary shelf

List Price \$7,060

See Vox® Forum configurator for additional Vox® Forum configurations (www.nienkamper.com/vfc_US/vox.html)
Contact customer service for further information.

GATEWAY™ WALL MOUNTED TABLES SPECIFICATIONS

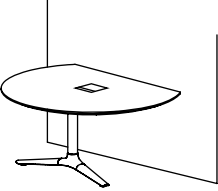
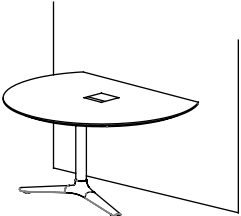
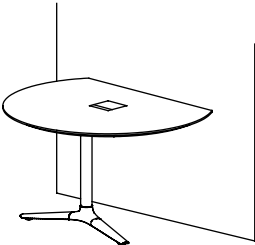
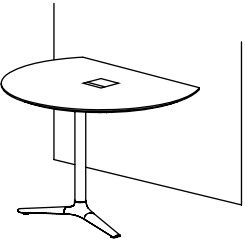
| | Model Number | Table Dimensions | Top Finish | List Price |
|--|----------------|-----------------------|-----------------|--------------|
| Wall Mounted Table: 22" Lounge Height  | 42221/2 | 48" dia x 22"h | Veneer | 4,085 |
| | 42221/5 | 48" dia x 22"h | Laminate | 3,485 |
| | 42222/2 | 58" dia x 22"h | Veneer | 4,880 |
| | 42222/5 | 58" dia x 22"h | Laminate | 3,970 |
| | <hr/> | | | |
| Wall Mounted Table: 26" Relaxed Work Height  | 42241/2 | 48" dia x 26"h | Veneer | 4,165 |
| | 42241/5 | 48" dia x 26"h | Laminate | 3,555 |
| | 42242/2 | 58" dia x 26"h | Veneer | 4,985 |
| | 42242/5 | 58" dia x 26"h | Laminate | 4,045 |
| | <hr/> | | | |
| Wall Mounted Table: 29" Standard Work Height  | 42223/2 | 48" dia x 29"h | Veneer | 4,245 |
| | 42223/5 | 48" dia x 29"h | Laminate | 3,630 |
| | 42224/2 | 58" dia x 29"h | Veneer | 5,080 |
| | 42224/5 | 58" dia x 29"h | Laminate | 4,130 |
| | <hr/> | | | |
| Wall Mounted Table: 38" Standing Height  | 42225/2 | 48" dia x 29"h | Veneer | 4,335 |
| | 42225/5 | 48" dia x 38"h | Laminate | 3,700 |
| | 42226/2 | 58" dia x 38"h | Veneer | 5,180 |
| | 42226/5 | 58" dia x 38"h | Laminate | 4,210 |
| | <hr/> | | | |

Connectivity devices are to be ordered separately and cost is not reflected in above pricing. Refer to page 14-15 for more information. Flat panel monitors and mounting brackets to be supplied by customer and are not included in above pricing.

GATEWAY™ WALL MOUNTED TABLES SPECIFICATIONS

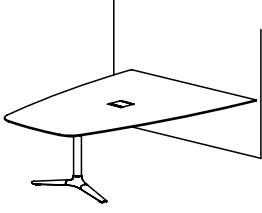
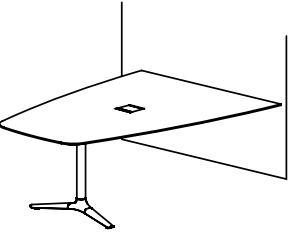
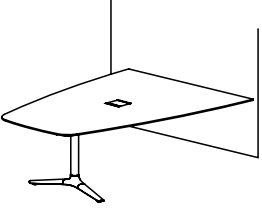
| | Model Number | Table Dimensions | Top Finish | List Price |
|---|-----------------------------------|---------------------------------------|-----------------|--------------|
| Wall Mounted Table: 26" Relaxed Work Height  | 42231/2 | 60"l x (21 3/4" - 45")w x 26"h | Veneer | 4,735 |
| | 42231/5 | 60"l x (21 3/4" - 45")w x 26"h | Laminate | 3,940 |
| | 42243/2 | 60"l x (32" - 55")w x 26"h | Veneer | 5,060 |
| | 42243/5 | 60"l x (32" - 55")w x 26"h | Laminate | 4,100 |
| | 42232/2 | 72"l x (21 3/4" - 45")w x 26"h | Veneer | 5,265 |
| | 42232/5 | 72"l x (21 3/4" - 45")w x 26"h | Laminate | 4,275 |
| | 42244/2 | 72"l x (32" - 55")w x 26"h | Veneer | 5,570 |
| | 42244/5 | 72"l x (32" - 55")w x 26"h | Laminate | 4,405 |
| | 42233/2 | 84"l x (21 3/4" - 45")w x 26"h | Veneer | 5,630 |
| | 42233/5 | 84"l x (21 3/4" - 45")w x 26"h | Laminate | 4,490 |
| 42245/2 | 84"l x (32" - 55")w x 26"h | Veneer | 6,040 | |
| 42245/5 | 84"l x (32" - 55")w x 26"h | Laminate | 4,665 | |
| Wall Mounted Table: 29" Standard Work Height  | 42227/2 | 60"l x (21 3/4" - 45")w x 29"h | Veneer | 4,830 |
| | 42227/5 | 60"l x (21 3/4" - 45")w x 29"h | Laminate | 4,025 |
| | 42237/2 | 60"l x (32" - 55")w x 29"h | Veneer | 5,165 |
| | 42237/5 | 60"l x (32" - 55")w x 29"h | Laminate | 4,180 |
| | 42228/2 | 72"l x (21 3/4" - 45")w x 29"h | Veneer | 5,370 |
| | 42228/5 | 72"l x (21 3/4" - 45")w x 29"h | Laminate | 4,360 |
| | 42238/2 | 72"l x (32" - 55")w x 29"h | Veneer | 5,690 |
| | 42238/5 | 72"l x (32" - 55")w x 29"h | Laminate | 4,490 |
| | 42229/2 | 84"l x (21 3/4" - 45")w x 29"h | Veneer | 5,740 |
| | 42229/5 | 84"l x (21 3/4" - 45")w x 29"h | Laminate | 4,580 |
| 42239/2 | 84"l x (32" - 55")w x 29"h | Veneer | 6,140 | |
| 42239/5 | 84"l x (32" - 55")w x 29"h | Laminate | 4,755 | |
| Wall Mounted Table: 38" Standing Height  | 42234/2 | 60"l x (21 3/4" - 45")w x 38"h | Veneer | 4,920 |
| | 42234/5 | 60"l x (21 3/4" - 45")w x 38"h | Laminate | 4,100 |
| | 42246/2 | 60"l x (32" - 55")w x 38"h | Veneer | 5,370 |
| | 42246/5 | 60"l x (32" - 55")w x 38"h | Laminate | 4,350 |
| | 42235/2 | 72"l x (21 3/4" - 45")w x 38"h | Veneer | 5,475 |
| | 42235/5 | 72"l x (21 3/4" - 45")w x 38"h | Laminate | 4,445 |
| | 42247/2 | 72"l x (32" - 55")w x 38"h | Veneer | 5,910 |
| | 42247/5 | 72"l x (32" - 55")w x 38"h | Laminate | 4,670 |
| | 42236/2 | 84"l x (21 3/4" - 45")w x 38"h | Veneer | 5,870 |
| | 42236/5 | 84"l x (21 3/4" - 45")w x 38"h | Laminate | 4,670 |
| 42248/2 | 84"l x (32" - 55")w x 38"h | Veneer | 6,405 | |
| 42248/5 | 84"l x (32" - 55")w x 38"h | Laminate | 4,945 | |

Connectivity devices are to be ordered separately and cost is not reflected in above pricing. Refer to page 14-15 for more information. Flat panel monitors and mounting brackets to be supplied by customer and are not included in above pricing.

GATEWAY™ CONFERENCE & STAND-ALONE TABLES

Top Options:

Dimensions:

4 table heights are standard to Gateway Tables, 22" lounge height, 26" relaxed conference height, 29" standard work height and 38" standing height.
 Table widths: 30" - 54"
 Table lengths are available from 60" - 216"
 Top thickness is 1.25"

Top Shape:

Standard top shapes are Vista, Boomerang, Rectangular, Super Ellipse, Boat, Racetrack, Square and Round.

Edges:

2" taper edge is standard but self edge are also available.
 Edge material may be solid wood or translucent plastic.

Material / Finishes:

Gateway table tops are available in all Nienkamper high quality veneers and finishes with grain lay up and options.
 All standard plastic laminates are also offered.

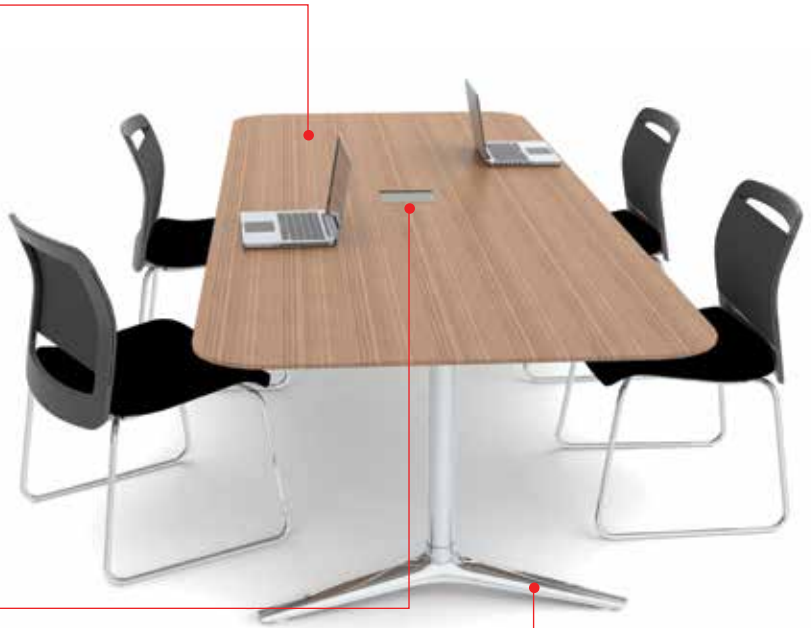

Connectivity Options:

Gateway Conference Tables are available with a range of connectivity devices to suit most.

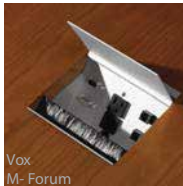

Base Features & Options:

Dimensions:

Gateway tables have 3 distinct base styles: 2 prong angled, 2 prong straight and cruciform.
 Bases are available in 24", 34" and 44" wide sizes.

Finishes:

Bases are standard with a mirror polished finish.
 Anodized finish in 5 standard colours (clear, champaign, light bronze, bronze, and black) are available.
 Combination of anodized post and mirror polished foot assembly is available as well.

Wire Management:

All Gateway bases allow for wires to pass through their support post and out the base foot to the floor.
 Standard Nienkamper cable conduit also available, see Vox® Planning Guide for pricing.



Post

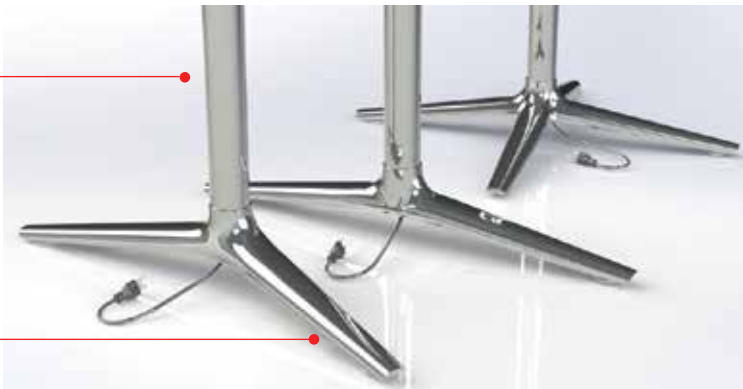

Foot Assembly



GATEWAY™ CONFERENCE TABLES

Table Top



Boomerang

Table height = 29"

Specify edge type: add the two letter code after the model number



Taper Edge (TE)



Self Edge (SE)



Facet Edge (FE)



Flowform Edge "FF"
5% upcharge
laminite not available



Camber Edge "CE"
5% upcharge

3 Bases

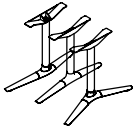

| L" x D" | Sugg Seat Capacity | Top Finish | Top Sections | Model Number | List Price |
|--------------------|--------------------|-----------------|--------------|----------------|---------------|
| 144 x 55/34 | 6-8 | Veneer | 2 | 42001/2 | 13,665 |
| 144 x 55/34 | 6-8 | Laminate | 2 | 42001/5 | 10,895 |
| 168 x 55/34 | 10-12 | Veneer | 2 | 42002/2 | 15,440 |
| 168 x 55/34 | 10-12 | Laminate | 2 | 42002/5 | 12,205 |
| 192 x 55/34 | 10-12 | Veneer | 2 | 42003/2 | 16,940 |
| 192 x 55/34 | 10-12 | Laminate | 2 | 42003/5 | 13,240 |

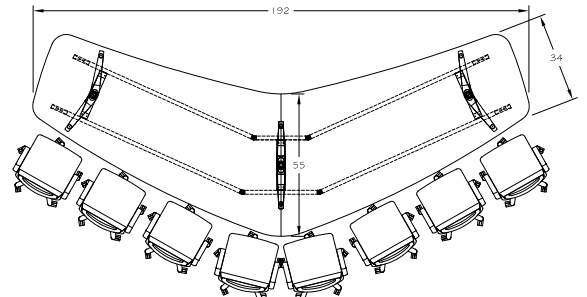
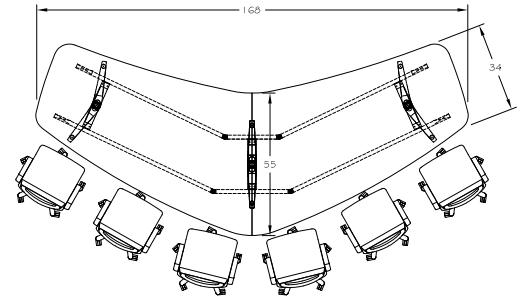
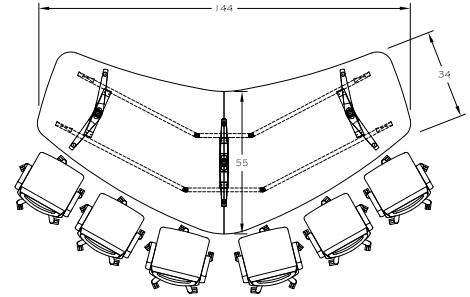

GATEWAY™ CONFERENCE TABLES



Table Top



Rectangle
with soft corners

Table height = 29"

Specify edge type: add the two letter code after the model number



Taper Edge (TE)



Self Edge (SE)



Facet Edge (FE)



Flowform Edge "FF"
5% upcharge
laminates not available



Camber Edge "CE"
5% upcharge

2 Bases

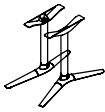

3 Bases

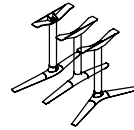

| L" | x | D" | Sugg Seat Capacity * | Top Finish | Top Sections | Model Number | List Price |
|------------|-----------|-------------|----------------------|-----------------|--------------|----------------|--------------|
| 60 | 30 | 4-6 | | Veneer | 1 | 42011/2 | 5,215 |
| 60 | 30 | 4-6 | | Laminate | 1 | 42011/5 | 4,745 |
| 72 | 36 | 6-8 | | Veneer | 1 | 42012/2 | 5,930 |
| 72 | 36 | 6-8 | | Laminate | 1 | 42012/5 | 5,255 |
| 84 | 42 | 6-8 | | Veneer | 1 | 42013/2 | 6,775 |
| 84 | 42 | 6-8 | | Laminate | 1 | 42013/5 | 5,740 |
| 96 | 42 | 6-8 | | Veneer | 1 | 42014/2 | 7,225 |
| 96 | 42 | 6-8 | | Laminate | 1 | 42014/5 | 6,060 |
| 96 | 48 | 6-8 | | Veneer | 1 | 42015/2 | 7,655 |
| 96 | 48 | 6-8 | | Laminate | 1 | 42015/5 | 6,280 |
| 108 | 42 | 8-10 | | Veneer | 1 | 42016/2 | 7,845 |
| 108 | 42 | 8-10 | | Laminate | 1 | 42016/5 | 6,480 |
| 108 | 48 | 8-10 | | Veneer | 1 | 42017/2 | 8,305 |
| 108 | 48 | 8-10 | | Laminate | 1 | 42017/5 | 6,740 |
| 120 | 42 | 8-10 | | Veneer | 2 | 42018/2 | 8,240 |
| 120 | 42 | 8-10 | | Laminate | 2 | 42018/5 | 6,695 |
| 120 | 48 | 8-10 | | Veneer | 2 | 42019/2 | 8,765 |
| 120 | 48 | 8-10 | | Laminate | 2 | 42019/5 | 7,015 |
| 120 | 54 | 8-10 | | Veneer | 2 | 42020/2 | 9,305 |
| 120 | 54 | 8-10 | | Laminate | 2 | 42020/5 | 7,390 |

| L" | x | D" | Sugg Seat Capacity * | Top Finish | Top Sections | Model Number | List Price |
|------------|-----------|--------------|----------------------|-----------------|--------------|----------------|---------------|
| 132 | 48 | 10-12 | | Veneer | 2 | 42021/2 | 10,685 |
| 132 | 48 | 10-12 | | Laminate | 2 | 42021/5 | 8,725 |
| 132 | 54 | 10-12 | | Veneer | 2 | 42022/2 | 11,270 |
| 132 | 54 | 10-12 | | Laminate | 2 | 42022/5 | 9,120 |
| 144 | 48 | 10-12 | | Veneer | 2 | 42023/2 | 11,140 |
| 144 | 48 | 10-12 | | Laminate | 2 | 42023/5 | 9,035 |
| 144 | 54 | 10-12 | | Veneer | 2 | 42024/2 | 11,760 |
| 144 | 54 | 10-12 | | Laminate | 2 | 42024/5 | 9,380 |
| 156 | 48 | 12-14 | | Veneer | 2 | 42026/2 | 11,670 |
| 156 | 48 | 12-14 | | Laminate | 2 | 42026/5 | 9,360 |
| 156 | 54 | 12-14 | | Veneer | 2 | 42027/2 | 12,355 |
| 156 | 54 | 12-14 | | Laminate | 2 | 42027/5 | 9,820 |
| 168 | 48 | 12-14 | | Veneer | 2 | 42029/2 | 12,660 |
| 168 | 48 | 12-14 | | Laminate | 2 | 42029/5 | 10,210 |
| 168 | 54 | 12-14 | | Veneer | 2 | 42030/2 | 13,475 |
| 168 | 54 | 12-14 | | Laminate | 2 | 42030/5 | 10,715 |
| 180 | 54 | 14-16 | | Veneer | 3 | 42032/2 | 14,090 |
| 180 | 54 | 14-16 | | Laminate | 3 | 42032/5 | 12,285 |
| 192 | 54 | 14-16 | | Veneer | 3 | 42034/2 | 14,670 |
| 192 | 54 | 14-16 | | Laminate | 3 | 42034/5 | 11,455 |
| 204 | 54 | 16-18 | | Veneer | 3 | 42036/2 | 15,190 |
| 204 | 54 | 16-18 | | Laminate | 3 | 42036/5 | 11,790 |
| 216 | 54 | 16-18 | | Veneer | 3 | 42038/2 | 15,760 |
| 216 | 54 | 16-18 | | Laminate | 3 | 42038/5 | 12,165 |

* Based on a chair width of 25"

GATEWAY™ CONFERENCE TABLES

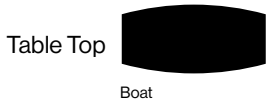
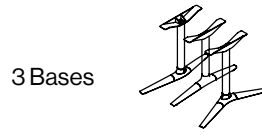
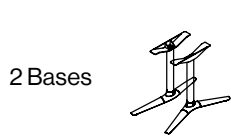

Table height = 29"

Specify edge type: add the two letter code after the model number



| L" | x | D" | Sugg Seat Capacity | Top Finish | Top Sections | Model Number | List Price | L" | x | D" | Sugg Seat Capacity | Top Finish | Top Sections | Model Number | List Price |
|------------|-----------|-------------|--------------------|-----------------|--------------|----------------|--------------|------------|-----------|--------------|--------------------|-----------------|--------------|----------------|---------------|
| 60 | 30 | 4-6 | | Veneer | 1 | 42041/2 | 5,085 | 132 | 48 | 10-12 | | Veneer | 2 | 42051/2 | 9,940 |
| 60 | 30 | 4-6 | | Laminate | 1 | 42041/5 | 4,645 | 132 | 48 | 10-12 | | Laminate | 2 | 42051/5 | 8,075 |
| 72 | 36 | 6-8 | | Veneer | 1 | 42042/2 | 5,815 | 132 | 54 | 10-12 | | Veneer | 2 | 42052/2 | 10,415 |
| 72 | 36 | 6-8 | | Laminate | 1 | 42042/5 | 5,045 | 132 | 54 | 10-12 | | Laminate | 2 | 42052/5 | 8,335 |
| 84 | 42 | 6-8 | | Veneer | 1 | 42043/2 | 6,430 | 144 | 48 | 10-12 | | Veneer | 2 | 42053/2 | 10,325 |
| 84 | 42 | 6-8 | | Laminate | 1 | 42043/5 | 5,410 | 144 | 48 | 10-12 | | Laminate | 2 | 42053/5 | 8,260 |
| 96 | 42 | 6-8 | | Veneer | 1 | 42044/2 | 6,765 | 144 | 54 | 10-12 | | Veneer | 2 | 42054/2 | 10,845 |
| 96 | 42 | 6-8 | | Laminate | 1 | 42044/5 | 5,630 | 144 | 54 | 10-12 | | Laminate | 2 | 42054/5 | 8,520 |
| 96 | 48 | 6-8 | | Veneer | 1 | 42045/2 | 7,150 | 156 | 48 | 12-14 | | Veneer | 2 | 42056/2 | 10,755 |
| 96 | 48 | 6-8 | | Laminate | 1 | 42045/5 | 5,775 | 156 | 48 | 12-14 | | Laminate | 2 | 42056/5 | 8,520 |
| 108 | 42 | 8-10 | | Veneer | 1 | 42046/2 | 7,305 | 156 | 54 | 12-14 | | Veneer | 2 | 42057/2 | 11,360 |
| 108 | 42 | 8-10 | | Laminate | 1 | 42046/5 | 5,975 | 156 | 54 | 12-14 | | Laminate | 2 | 42057/5 | 8,855 |
| 108 | 48 | 8-10 | | Veneer | 1 | 42047/2 | 7,725 | 168 | 48 | 12-14 | | Veneer | 2 | 42059/2 | 11,725 |
| 108 | 48 | 8-10 | | Laminate | 1 | 42047/5 | 6,260 | 168 | 48 | 12-14 | | Laminate | 2 | 42059/5 | 9,310 |
| 120 | 42 | 8-10 | | Veneer | 2 | 42048/2 | 7,635 | 168 | 54 | 12-14 | | Veneer | 2 | 42060/2 | 12,415 |
| 120 | 42 | 8-10 | | Laminate | 2 | 42048/5 | 6,155 | 168 | 54 | 12-14 | | Laminate | 2 | 42060/5 | 9,700 |
| 120 | 48 | 8-10 | | Veneer | 2 | 42049/2 | 8,110 | 180 | 54 | 14-16 | | Veneer | 3 | 42062/2 | 12,905 |
| 120 | 48 | 8-10 | | Laminate | 2 | 42049/5 | 6,410 | 180 | 54 | 14-16 | | Laminate | 3 | 42062/5 | 9,930 |
| 120 | 54 | 8-10 | | Veneer | 2 | 42050/2 | 8,530 | 192 | 54 | 14-16 | | Veneer | 4 | 42064/2 | 13,425 |
| 120 | 54 | 8-10 | | Laminate | 2 | 42050/5 | 6,650 | 192 | 54 | 14-16 | | Laminate | 4 | 42064/5 | 10,230 |
| | | | | | | | | 204 | 54 | 16-18 | | Veneer | 4 | 42066/2 | 13,865 |
| | | | | | | | | 204 | 54 | 16-18 | | Laminate | 4 | 42066/5 | 10,525 |
| | | | | | | | | 216 | 54 | 16-18 | | Veneer | 4 | 42068/2 | 14,320 |
| | | | | | | | | 216 | 54 | 16-18 | | Laminate | 4 | 42068/5 | 10,795 |

* Based on a chair width of 25"

GATEWAY™ CONFERENCE TABLES

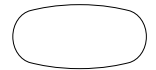
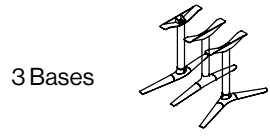
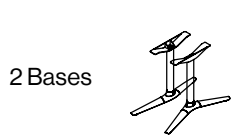

Table height = 29"

Specify edge type: add the two letter code after the model number



| L" | x | D" | Sugg Seat Capacity | Top Finish | Top Sections | Model Number | List Price | L" | x | D" | Sugg Seat Capacity | Top Finish | Top Sections | Model Number | List Price |
|------------|---|-----------|--------------------|-----------------|--------------|----------------|--------------|------------|---|-----------|--------------------|-----------------|--------------|----------------|---------------|
| 60 | | 30 | 4-6 | Veneer | 1 | 42071/2 | 5,335 | 132 | | 48 | 10-12 | Veneer | 2 | 42081/2 | 10,425 |
| 60 | | 30 | 4-6 | Laminate | 1 | 42071/5 | 4,865 | 132 | | 48 | 10-12 | Laminate | 2 | 42081/5 | 8,470 |
| 72 | | 36 | 6-8 | Veneer | 1 | 42072/2 | 6,100 | 132 | | 54 | 10-12 | Veneer | 2 | 42082/2 | 10,925 |
| 72 | | 36 | 6-8 | Laminate | 1 | 42072/5 | 5,290 | 132 | | 54 | 10-12 | Laminate | 2 | 42082/5 | 8,735 |
| 84 | | 42 | 6-8 | Veneer | 1 | 42073/2 | 6,730 | 144 | | 48 | 10-12 | Veneer | 2 | 42083/2 | 10,830 |
| 84 | | 42 | 6-8 | Laminate | 1 | 42073/5 | 5,680 | 144 | | 48 | 10-12 | Laminate | 2 | 42083/5 | 8,660 |
| 96 | | 42 | 6-8 | Veneer | 1 | 42074/2 | 7,100 | 144 | | 54 | 10-12 | Veneer | 2 | 42084/2 | 11,375 |
| 96 | | 42 | 6-8 | Laminate | 1 | 42074/5 | 5,910 | 144 | | 54 | 10-12 | Laminate | 2 | 42084/5 | 8,940 |
| 96 | | 48 | 6-8 | Veneer | 1 | 42075/2 | 7,495 | 156 | | 48 | 12-14 | Veneer | 2 | 42086/2 | 11,275 |
| 96 | | 48 | 6-8 | Laminate | 1 | 42075/5 | 6,070 | 156 | | 48 | 12-14 | Laminate | 2 | 42086/5 | 8,940 |
| 108 | | 42 | 8-10 | Veneer | 1 | 42076/2 | 7,665 | 156 | | 54 | 12-14 | Veneer | 2 | 42087/2 | 11,915 |
| 108 | | 42 | 8-10 | Laminate | 1 | 42076/5 | 6,280 | 156 | | 54 | 12-14 | Laminate | 2 | 42087/5 | 9,280 |
| 108 | | 48 | 8-10 | Veneer | 1 | 42077/2 | 8,105 | 168 | | 48 | 12-14 | Veneer | 2 | 42089/2 | 12,290 |
| 108 | | 48 | 8-10 | Laminate | 1 | 42077/5 | 6,555 | 168 | | 48 | 12-14 | Laminate | 2 | 42089/5 | 9,750 |
| 120 | | 42 | 8-10 | Veneer | 2 | 42078/2 | 8,005 | 168 | | 54 | 12-14 | Veneer | 2 | 42090/2 | 13,010 |
| 120 | | 42 | 8-10 | Laminate | 2 | 42078/5 | 6,470 | 168 | | 54 | 12-14 | Laminate | 2 | 42090/5 | 10,165 |
| 120 | | 48 | 8-10 | Veneer | 2 | 42079/2 | 8,505 | 180 | | 54 | 14-16 | Veneer | 3 | 42092/2 | 13,535 |
| 120 | | 48 | 8-10 | Laminate | 2 | 42079/5 | 6,705 | 180 | | 54 | 14-16 | Laminate | 3 | 42092/5 | 10,415 |
| 120 | | 54 | 8-10 | Veneer | 2 | 42080/2 | 8,945 | 192 | | 54 | 14-16 | Veneer | 3 | 42094/2 | 14,070 |
| 120 | | 54 | 8-10 | Laminate | 2 | 42080/5 | 6,970 | 192 | | 54 | 14-16 | Laminate | 3 | 42094/5 | 10,730 |
| | | | | | | | | 204 | | 54 | 16-18 | Veneer | 3 | 42096/2 | 14,540 |
| | | | | | | | | 204 | | 54 | 16-18 | Laminate | 3 | 42096/5 | 11,035 |
| | | | | | | | | 216 | | 54 | 16-18 | Veneer | 3 | 42098/2 | 15,020 |
| | | | | | | | | 216 | | 54 | 16-18 | Laminate | 3 | 42098/5 | 11,315 |

* Based on a chair width of 25"

GATEWAY™ CONFERENCE TABLES

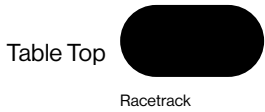
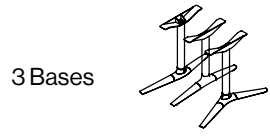
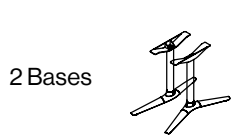

Table height = 29"

Specify edge type: add the two letter code after the model number



| L" | x | D" | Sugg Seat Capacity * | Top Finish | Top Sections | Model Number | List Price | L" | x | D" | Sugg Seat Capacity * | Top Finish | Top Sections | Model Number | List Price |
|------------|---|-----------|----------------------|-----------------|--------------|----------------|--------------|------------|---|-----------|----------------------|-----------------|--------------|----------------|---------------|
| 60 | | 30 | 4-6 | Veneer | 1 | 42101/2 | 5,210 | 132 | | 48 | 10-12 | Veneer | 2 | 42111/2 | 10,185 |
| 60 | | 30 | 4-6 | Laminate | 1 | 42101/5 | 4,755 | 132 | | 48 | 10-12 | Laminate | 2 | 42111/5 | 8,275 |
| 72 | | 36 | 6-8 | Veneer | 1 | 42102/2 | 5,950 | 132 | | 54 | 10-12 | Veneer | 2 | 42112/2 | 10,675 |
| 72 | | 36 | 6-8 | Laminate | 1 | 42102/5 | 5,170 | 132 | | 54 | 10-12 | Laminate | 2 | 42112/5 | 8,540 |
| 84 | | 42 | 6-8 | Veneer | 1 | 42103/2 | 6,565 | 144 | | 48 | 10-12 | Veneer | 2 | 42113/2 | 10,580 |
| 84 | | 42 | 6-8 | Laminate | 1 | 42103/5 | 5,540 | 144 | | 48 | 10-12 | Laminate | 2 | 42113/5 | 8,460 |
| 96 | | 42 | 6-8 | Veneer | 1 | 42104/2 | 6,935 | 144 | | 54 | 10-12 | Veneer | 2 | 42114/2 | 11,105 |
| 96 | | 42 | 6-8 | Laminate | 1 | 42104/5 | 5,770 | 144 | | 54 | 10-12 | Laminate | 2 | 42114/5 | 8,725 |
| 96 | | 48 | 6-8 | Veneer | 1 | 42105/2 | 7,320 | 156 | | 48 | 12-14 | Veneer | 2 | 42116/2 | 11,020 |
| 96 | | 48 | 6-8 | Laminate | 1 | 42105/5 | 5,920 | 156 | | 48 | 12-14 | Laminate | 2 | 42116/5 | 8,725 |
| 108 | | 42 | 8-10 | Veneer | 1 | 42106/2 | 7,485 | 156 | | 54 | 12-14 | Veneer | 2 | 42117/2 | 11,630 |
| 108 | | 42 | 8-10 | Laminate | 1 | 42106/5 | 6,125 | 156 | | 54 | 12-14 | Laminate | 2 | 42117/5 | 9,065 |
| 108 | | 48 | 8-10 | Veneer | 1 | 42107/2 | 7,920 | 168 | | 48 | 12-14 | Veneer | 2 | 42119/2 | 12,005 |
| 108 | | 48 | 8-10 | Laminate | 1 | 42107/5 | 6,420 | 168 | | 48 | 12-14 | Laminate | 2 | 42119/5 | 9,525 |
| 120 | | 42 | 8-10 | Veneer | 2 | 42108/2 | 7,820 | 168 | | 54 | 12-14 | Veneer | 2 | 42120/2 | 12,695 |
| 120 | | 42 | 8-10 | Laminate | 2 | 42108/5 | 6,315 | 168 | | 54 | 12-14 | Laminate | 2 | 42120/5 | 9,930 |
| 120 | | 48 | 8-10 | Veneer | 2 | 42109/2 | 8,305 | 180 | | 54 | 14-16 | Veneer | 3 | 42122/2 | 13,230 |
| 120 | | 48 | 8-10 | Laminate | 2 | 42109/5 | 6,540 | 180 | | 54 | 14-16 | Laminate | 3 | 42122/5 | 10,180 |
| 120 | | 54 | 8-10 | Veneer | 2 | 42110/2 | 8,730 | 192 | | 54 | 14-16 | Veneer | 3 | 42124/2 | 13,750 |
| 120 | | 54 | 8-10 | Laminate | 2 | 42110/5 | 6,820 | 192 | | 54 | 14-16 | Laminate | 3 | 42124/5 | 10,490 |
| | | | | | | | | 204 | | 54 | 16-18 | Veneer | 3 | 42126/2 | 14,205 |
| | | | | | | | | 204 | | 54 | 16-18 | Laminate | 3 | 42126/5 | 10,775 |
| | | | | | | | | 216 | | 54 | 16-18 | Veneer | 3 | 42128/2 | 14,665 |
| | | | | | | | | 216 | | 54 | 16-18 | Laminate | 3 | 42128/5 | 11,050 |

* Based on a chair width of 25"

GATEWAY™ CONFERENCE TABLES



Specify edge type: add the two letter code after the model number

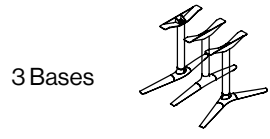
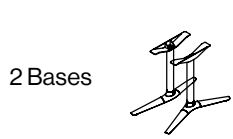

| L" x D" | Sugg Seat Capacity* | Top Finish | Top Sections | Model Number | List Price |
|------------------|---------------------|-----------------|--------------|----------------|--------------|
| 96 33-48 | 6-8 | Veneer | 1 | 42135/2 | 8,025 |
| 96 33-48 | 6-8 | Laminate | 1 | 42135/5 | 6,485 |
| 108 33-48 | 8-10 | Veneer | 1 | 42137/2 | 8,675 |
| 108 33-48 | 8-10 | Laminate | 1 | 42137/5 | 7,020 |
| 120 33-48 | 8-10 | Veneer | 2 | 42139/2 | 9,095 |
| 120 33-48 | 8-10 | Laminate | 2 | 42139/5 | 7,175 |
| 120 38-54 | 8-10 | Veneer | 2 | 42140/2 | 9,560 |
| 120 38-54 | 8-10 | Laminate | 2 | 42140/5 | 7,460 |

| L" x D" | Sugg Seat Capacity* | Top Finish | Top Sections | Model Number | List Price |
|------------------|---------------------|-----------------|--------------|----------------|---------------|
| 132 33-48 | 10-12 | Veneer | 2 | 42141/2 | 11,155 |
| 132 33-48 | 10-12 | Laminate | 2 | 42141/5 | 9,060 |
| 132 38-54 | 10-12 | Veneer | 2 | 42142/2 | 11,695 |
| 132 38-54 | 10-12 | Laminate | 2 | 42142/5 | 9,345 |
| 144 33-48 | 10-12 | Veneer | 2 | 42143/2 | 11,585 |
| 144 33-48 | 10-12 | Laminate | 2 | 42143/5 | 9,260 |
| 144 38-54 | 10-12 | Veneer | 2 | 42144/2 | 12,160 |
| 144 38-54 | 10-12 | Laminate | 2 | 42144/5 | 9,550 |
| 156 33-48 | 12-14 | Veneer | 2 | 42146/2 | 12,070 |
| 156 33-48 | 12-14 | Laminate | 2 | 42146/5 | 9,550 |
| 156 38-54 | 12-14 | Veneer | 2 | 42147/2 | 12,735 |
| 156 38-54 | 12-14 | Laminate | 2 | 42147/5 | 9,925 |
| 168 33-48 | 12-14 | Veneer | 2 | 42149/2 | 13,150 |
| 168 33-48 | 12-14 | Laminate | 2 | 42149/5 | 10,430 |
| 168 38-54 | 12-14 | Veneer | 2 | 42150/2 | 13,905 |
| 168 38-54 | 12-14 | Laminate | 2 | 42150/5 | 10,870 |
| 180 38-54 | 14-16 | Veneer | 3 | 42152/2 | 14,480 |
| 180 38-54 | 14-16 | Laminate | 3 | 42152/5 | 11,140 |
| 192 38-54 | 14-16 | Veneer | 3 | 42154/2 | 15,060 |
| 192 38-54 | 14-16 | Laminate | 3 | 42154/5 | 11,475 |
| 204 38-54 | 16-18 | Veneer | 3 | 42156/2 | 15,550 |
| 204 38-54 | 16-18 | Laminate | 3 | 42156/5 | 11,800 |
| 216 38-54 | 16-18 | Veneer | 3 | 42158/2 | 16,065 |
| 216 38-54 | 16-18 | Laminate | 3 | 42158/5 | 12,100 |

* Based on a chair width of 25"

GATEWAY™ CONFERENCE TABLES



Specify edge type: add the two letter code after the model number



Standard Height (29")



| L" | x | D" | Sugg Seat Capacity | Top Finish | Top Sections | Model Number | List Price |
|-----------|-----------|------------|--------------------|-----------------|--------------|----------------|--------------|
| 24 | 24 | 2 | | Veneer | 1 | 42161/2 | 3,320 |
| 24 | 24 | 2 | | Laminate | 1 | 42161/5 | 3,195 |
| 30 | 30 | 2 | | Veneer | 1 | 42162/2 | 3,675 |
| 30 | 30 | 2 | | Laminate | 1 | 42162/5 | 3,480 |
| 36 | 36 | 2 | | Veneer | 1 | 42163/2 | 4,035 |
| 36 | 36 | 2 | | Laminate | 1 | 42163/5 | 3,755 |
| 42 | 42 | 2-4 | | Veneer | 1 | 42164/2 | 4,545 |
| 42 | 42 | 2-4 | | Laminate | 1 | 42164/5 | 4,065 |
| 48 | 48 | 2-4 | | Veneer | 1 | 42165/2 | 4,890 |
| 48 | 48 | 2-4 | | Laminate | 1 | 42165/5 | 4,285 |

Lounge Height (22")

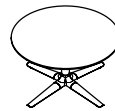

| L" | x | D" | Sugg Seat Capacity | Top Finish | Top Sections | Model Number | List Price |
|-----------|-----------|------------|--------------------|-----------------|--------------|----------------|--------------|
| 24 | 24 | 2 | | Veneer | 1 | 42166/2 | 3,320 |
| 24 | 24 | 2 | | Laminate | 1 | 42166/5 | 3,195 |
| 30 | 30 | 2 | | Veneer | 1 | 42167/2 | 3,675 |
| 30 | 30 | 2 | | Laminate | 1 | 42167/5 | 3,480 |
| 36 | 36 | 2 | | Veneer | 1 | 42168/2 | 4,035 |
| 36 | 36 | 2 | | Laminate | 1 | 42168/5 | 3,755 |
| 42 | 42 | 2-4 | | Veneer | 1 | 42169/2 | 4,545 |
| 42 | 42 | 2-4 | | Laminate | 1 | 42169/5 | 4,065 |
| 48 | 48 | 2-4 | | Veneer | 1 | 42170/2 | 4,890 |
| 48 | 48 | 2-4 | | Laminate | 1 | 42170/5 | 4,285 |



| L" | x | D" | Sugg Seat Capacity | Top Finish | Top Sections | Model Number | List Price |
|-----------|-----------|------------|--------------------|-----------------|--------------|----------------|--------------|
| 24 | 24 | 2 | | Veneer | 1 | 42171/2 | 3,320 |
| 24 | 24 | 2 | | Laminate | 1 | 42171/5 | 3,195 |
| 30 | 30 | 2 | | Veneer | 1 | 42172/2 | 3,675 |
| 30 | 30 | 2 | | Laminate | 1 | 42172/5 | 3,480 |
| 36 | 36 | 2 | | Veneer | 1 | 42173/2 | 4,035 |
| 36 | 36 | 2 | | Laminate | 1 | 42173/5 | 3,755 |
| 42 | 42 | 2-4 | | Veneer | 1 | 42174/2 | 4,545 |
| 42 | 42 | 2-4 | | Laminate | 1 | 42174/5 | 4,065 |

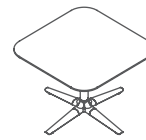

| L" | x | D" | Sugg Seat Capacity | Top Finish | Top Sections | Model Number | List Price |
|-----------|-----------|------------|--------------------|-----------------|--------------|----------------|--------------|
| 24 | 24 | 2 | | Veneer | 1 | 42176/2 | 3,320 |
| 24 | 24 | 2 | | Laminate | 1 | 42176/5 | 3,195 |
| 30 | 30 | 2 | | Veneer | 1 | 42177/2 | 3,675 |
| 30 | 30 | 2 | | Laminate | 1 | 42177/5 | 3,480 |
| 36 | 36 | 2 | | Veneer | 1 | 42178/2 | 4,035 |
| 36 | 36 | 2 | | Laminate | 1 | 42178/5 | 3,755 |
| 42 | 42 | 2-4 | | Veneer | 1 | 42179/2 | 4,545 |
| 42 | 42 | 2-4 | | Laminate | 1 | 42179/5 | 4,065 |

* Based on a chair width of 25"



GATEWAY™ LOUNGE

Upholstered Lounge Elements:

Dimensions: 6 basic upholstered elements make up the Gateway Lounge system.

Linear bench element- 28"w x 24.5"d x 17"h
Linear sofa element- 28"w x 29.5"d x 32"h

Convex bench element- 40"w x 24.5"d x 17"h
Convex sofa element- 40"w x 29.5"d x 32"h

Concave bench element- 41"w x 24.5"d x 17"h
Concave sofa element- 41"w x 29.5"d x 32"h

Fabrics: Gateway Lounge elements are available in a range of both solid matching pattern and colours and contrasting combinations. COM is also acceptable in most cases (contact customer service for details).



Accessories:

Privacy Screens: Intermediate and tall height, integrated screens offer privacy and sound dampening to any concave or convex sofa element.

Dimensions: Convex: intermediate height 23"w x 23"h / tall height 23"w x 44"h
Concave: intermediate height 41"w x 23"h / tall height 41"w x 44"h

Fabrics: Gateway Lounge Privacy Screens are available in COM and Unika Vaev fabrics.

Screen Table: An optional, shallow curved table can be added to the privacy screen to allow for tiered seating and table top behind the sofa.





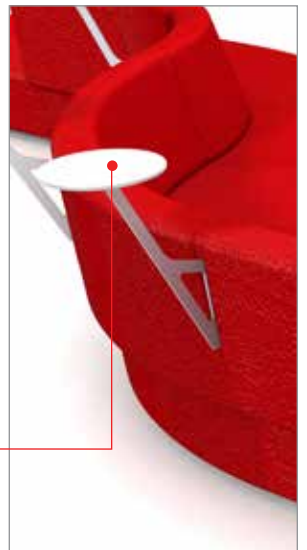

Dimensions: Convex 9"d x 23"w x 1"
Concave 9"d x 23" x 1"

Finishes: Tops are 1-1/4" thick with a taper edge available in Nienkamper standard veneers and finishes as well as plastic laminates.

Round Sofa Table: An optional 14" round table can be added to any Gateway Lounge element, mounting to either front or back of the sofa or bench. The mounting bracket is powder coated silver as standard, chrome is also available for an upcharge.



GATEWAY™ LOUNGE

| | Model Number | Seat H" | W" | D" | H" | Fabric Yds. | Leather Sq. Ft. | COM | COL | Verde | Grano | Cremoso | — US ONLY — | | | |
|---|--------------|---------|-----|--------|-----|-------------|-----------------|-------|-------|-------|-------|---------|-------------|-------|---------|-------|
| | | | | | | | | | | | | | Unika | Vaev | Fabrics | |
| | | | | | | | | | | | | | 1 | 2 | 3 | 4 |
| CONVEX | | | | | | | | | | | | | | | | |
| BENCH ELEMENT | | | | | | | | | | | | | | | | |
|  | 11411 | 17" | 40" | 245/8" | 17" | 21/4 | 108 | 1,995 | 2,100 | 2,840 | 3,045 | 3,350 | 2,175 | 2,245 | 2,295 | 2,385 |
| SOFA ELEMENT | | | | | | | | | | | | | | | | |
|  | 11412 | 17" | 40" | 291/2" | 32" | 41/2 | 108 | 3,555 | 3,735 | 5,220 | 5,640 | 6,245 | 3,910 | 4,045 | 4,150 | 4,335 |
| CONCAVE | | | | | | | | | | | | | | | | |
| BENCH ELEMENT | | | | | | | | | | | | | | | | |
|  | 11413 | 17" | 41" | 245/8" | 17" | 21/4 | 108 | 1,995 | 2,100 | 2,840 | 3,045 | 3,350 | 2,175 | 2,245 | 2,295 | 2,385 |
| SOFA ELEMENT | | | | | | | | | | | | | | | | |
|  | 11414 | 17" | 41" | 291/2" | 32" | 41/2 | 108 | 3,555 | 3,735 | 5,220 | 5,640 | 6,245 | 3,910 | 4,045 | 4,150 | 4,335 |
| STRAIGHT | | | | | | | | | | | | | | | | |
| BENCH ELEMENT | | | | | | | | | | | | | | | | |
|  | 11415 | 17" | 28" | 245/8" | 17" | 21/4 | 108 | 1,895 | 1,920 | 2,720 | 2,935 | 3,230 | 2,060 | 2,125 | 2,180 | 2,270 |
| SOFA ELEMENT | | | | | | | | | | | | | | | | |
|  | 11416 | 17" | 28" | 291/2" | 32" | 41/2 | 108 | 3,445 | 3,620 | 5,110 | 5,530 | 6,110 | 3,805 | 3,930 | 4,030 | 4,215 |

Features:

Gateway™ upholstered lounge elements include linear and curved modular components which enable the customer to create their own solution. Element styles are bench, sofa and sofa with integrated privacy screen.





GATEWAY™ ACCESSORY

— US ONLY —
Unika Vaev Fabrics
1 2 3 4



| Model Number | Seat H" | W" | D" | H" | Fabric Yds. | Leather Sq. Ft. | COM | COL | Verde | Grano | Cremoso | Unika 1 | Vaev 2 | Fabrics 3 | 4 |
|--------------|---------|----|----|----|-------------|-----------------|-----|-----|-------|-------|---------|---------|--------|-----------|---|
|--------------|---------|----|----|----|-------------|-----------------|-----|-----|-------|-------|---------|---------|--------|-----------|---|

PRIVACY SCREEN

CONVEX

| | | | | | | | | | | | | | | | |
|---|-------|-------------------------------|-------|-----|---|----|-------|-------|-------|-------|-------|-------|-------|-------|-------|
|  | 11421 | Tall Height | 42.5" | 59" | 3 | 54 | 1,270 | 1,330 | 2,380 | 2,655 | 2,990 | 1,505 | 1,590 | 1,665 | 1,785 |
| | 11422 | Low Height | 42.5" | 44" | 2 | 36 | 1,040 | 1,095 | 1,785 | 1,970 | 2,200 | 1,195 | 1,265 | 1,305 | 1,385 |
|  | 11423 | Low Height with 9" deep shelf | 42.5" | 44" | 2 | 36 | 1,495 | 1,570 | 2,255 | 2,440 | 2,680 | 1,655 | 1,710 | 1,760 | 1,840 |

CONCAVE

| | | | | | | | | | | | | | | | |
|--|-------|-----------------------------|-------|-----|---|----|-------|-------|-------|-------|-------|-------|-------|-------|-------|
|  | 11424 | Tall Height | 42.5" | 59" | 3 | 54 | 1,270 | 1,330 | 2,380 | 2,655 | 2,990 | 1,505 | 1,590 | 1,665 | 1,785 |
| | 11425 | Low Height | 42.5" | 44" | 2 | 36 | 1,040 | 1,095 | 1,785 | 1,970 | 2,200 | 1,195 | 1,265 | 1,305 | 1,385 |
|  | 11426 | Low Height with 9" deep top | 42.5" | 44" | 2 | 36 | 1,495 | 1,570 | 2,255 | 2,440 | 2,680 | 1,655 | 1,710 | 1,760 | 1,840 |

ROUND SOFA TABLE

| | | | | | | | | | | | | | | | |
|---|-------|----------|--|--|--|--|-------|--|--|--|--|--|--|--|--|
|  | 11431 | 14" dia. | | | | | 1,155 | | | | | | | | |
|---|-------|----------|--|--|--|--|-------|--|--|--|--|--|--|--|--|

Feature:

Privacy screens can be contrasting or matching fabrics

Consists of:
2 concave sofa elements
2 straight sofa elements
2 straight bench elements
3 round sofa tables

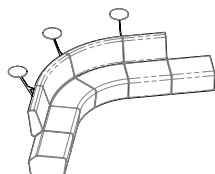

Consists of:
3 convex sofa elements
4 concave sofa elements

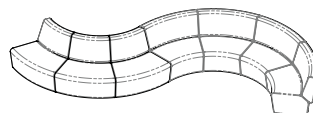

Consists of:
5 concave sofa elements
5 concave tall screens

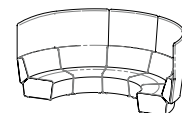

nienkämper

