

# METRONOME™ FLIPTOP

Fig40



nienkämper

# METRONOME™ FLIPTOP | SURFACE SHAPES, EDGE & BASE DETAILS

## SHAPES AND EDGE DETAILS

All standard Nienkämper veneers and laminates.

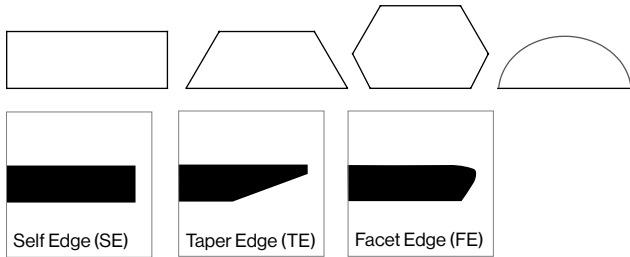

## DIMENSIONS

### Top Depths:

min 24" / 30" / 36"

### Top Lengths:

60", 66", 72", 78", 84", 90"

### Top Thickness:

1" & 1¼"

### Table Height:

29" for both 1" and 1¼" tops

### Modesty Panel:

Available in veneer & P-Lam

### Base:

24" top with 18" wide centre to center case (on caster)

30" top with 23" wide centre to center case (on caster)

36" top with 29" wide centre to center case (on caster)

### Lock Release:

Centred fabric / leather pull tab releases locking mechanism

## TOP FINISHES

Range from plastic laminate with high impact Translucent edge to veneer with solid wood edging.

## OPTIONS INCLUDE

Power/data AV solution, modesty panel, ganging hardware, wire management and flush or inset leg placement with locking casters.

## BASE FINISHES

Metronome™ FlipTop Tables are offered in a variety of finish options. Finishes can be matching or mixed to create a unique combination.

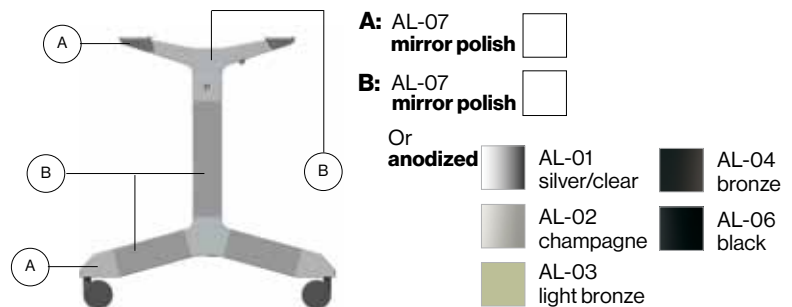

**A & B** in powder coat paint finish, see below options:

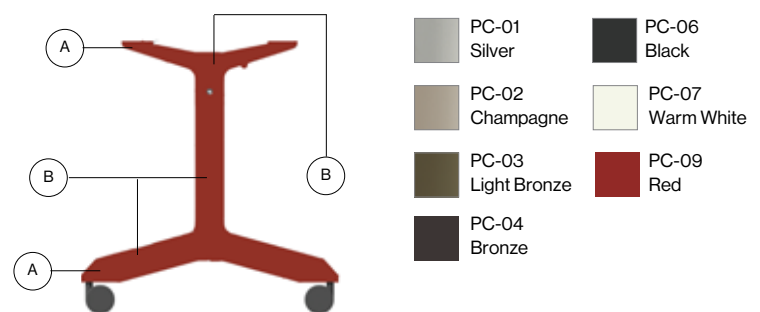

Metronome FlipTop Table base in red powder coat finish PC-09

For tables with bases in powder coat, list price is the same as anodized bases. To select powder coat finish, please use the model # of anodized bases and add "PC" at the end. For example, 30662PC/2 is a 60"Lx24"Wx29"H Metronome FlipTop Table with 1" thick top and flush bases in powder coat finish.

**Note:** Stretcher rails are always silver anodized finish

## KEY FEATURES

- Aluminum base with locking casters
- Styling and finish to match the Metronome Conference line
- Self locking hinges
- Extruded and cast aluminum base construction
- Unique flexible hinged modesty panel
- Polished and painted finish available
- All standard p.lam and veneers available
- Self edge standard
- Locking, soft tread casters
- Table compatible with Vox® Forums and SIMPLE Forum

## METRONOME™ FLIPTOP | BASE CONSTRUCTION

Aluminum is the only material used in the base construction ensuring a high degree of recycled content, and a complete opportunity for full recyclability for all elements.

The table rolls on 4 swiveling / locking 3" dia. casters. Base, hinge, stretcher rail, pull tab and casters are all integrated within the base structure.

The flip top bases are in anodized aluminum with polished aluminum details at the top and bottom or fully polished aluminum. Bases are connected with stretcher rail available in clear anodized aluminum finish only.



## METRONOME™ FLIPTOP | BASE POSITION

Bases for rectangle shape are offered in two positions, flush and inset.

Flush leg position allows the user maximum knee space when tables are ganged together.

Inset leg position allow the maximum seating capacity when tables are ganged together by enabling seating on table seams.

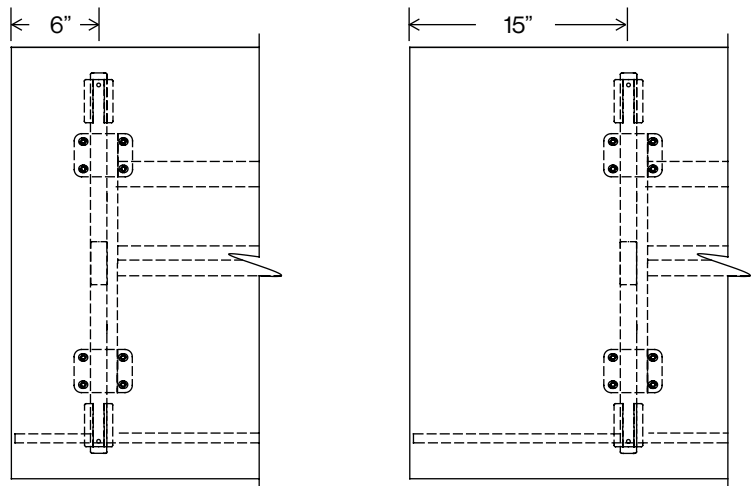

## METRONOME™ FLIPTOP | STORAGE REQUIREMENTS

Table Length	2 Tables	4 Tables	6 Tables	8 Tables	10 Tables	12 Tables
floor space required when nested for table depths of 24", 30" and 36" (L" x D")						
60"	34 x 63	49 x 69	65 x 75	80 x 81	95 x 87	111 x 93
66"	34 x 69	49 x 75	65 x 81	80 x 87	95 x 93	111 x 99
72"	34 x 75	49 x 81	65 x 87	80 x 93	95 x 99	111 x 105
78"	34 x 81	49 x 87	65 x 93	80 x 99	95 x 105	111 x 111
84"	34 x 87	49 x 93	65 x 99	80 x 105	95 x 111	111 x 117
90"	34 x 93	49 x 99	65 x 105	80 x 111	95 x 117	111 x 123

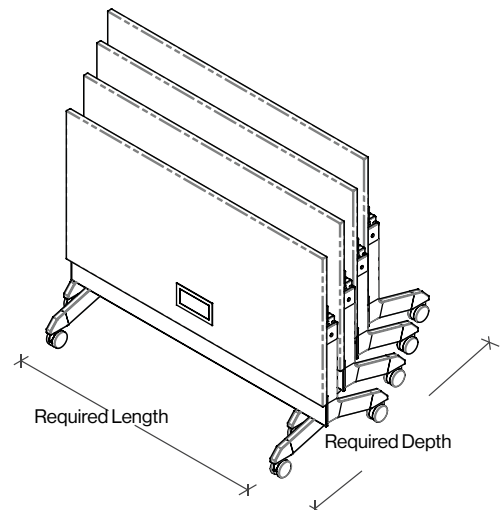

## METRONOME™ FLIPTOP | CONNECTIVITY MANAGEMENT

Metronome™ FlipTop can be specified with a range of connectivity devices to suit most technology and price point requirements.

For connectivity device details and pricing visit [www.nienkamper.com](http://www.nienkamper.com) or contact customer service at 1.800.668.9318.



SIMPLE Pop-Up Forum



SIMPLE Forum



Vox® Training Forum



Vox® S-Forum



Vox® M-Forum

## METRONOME™ FLIPTOP | WIRE MANAGEMENT

Tables that include connectivity devices are equipped with cable clips that are fixed to both the underside of the top and the base. Cables may be routed to either base according to user needs.



# METRONOME™ FLIPTOP | CONFIGURATIONS

---



2 rectangle tables

Model #    Dimensions  
30664/2    72"w x 24"d



2 trapezoid tables

Model #    Dimensions  
30846/2    84"w x 24"d

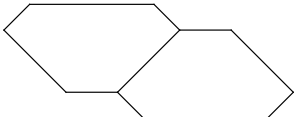

2 multi-angle tables

Model #    Dimensions  
30996/2    84"w x 30"d



4 rectangle tables & 2 half round tables

Model #    Dimensions  
30662/2    60"w x 24"d  
31079/2    48"w x 24"d

# METRONOME™ FLIPTOP | CONFIGURATIONS

---

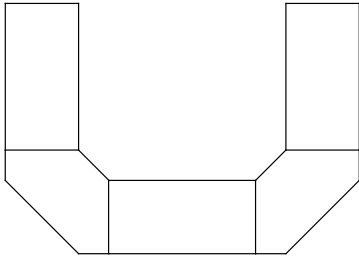

3 rectangle tables & 2 multi-angle tables

Model #	Dimensions
30670/2	72"w x 30"d
30994/2	72"w x 30"d

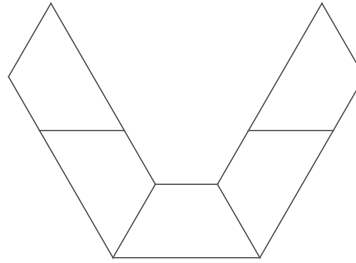

5 trapezoid tables

Model #	Dimensions
30850/2	72"w x 30"d

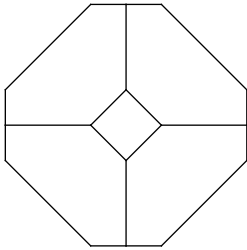

4 multi-angle tables

Model #	Dimensions
31002/2	84"w x 36"d

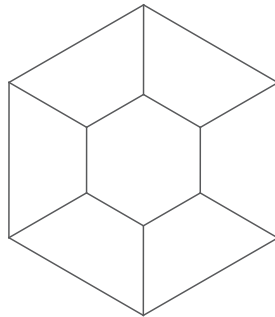

6 trapezoid tables

Model #	Dimensions
30858/2	84"w x 36"d

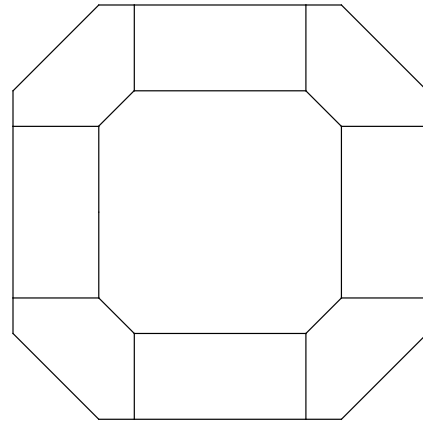

4 rectangle tables & 4 multi-angle tables

Model #	Dimensions
30679/2	90"w x 36"d
30859/2	90"w x 36"d

# METRONOME™ FLIPTOP | WITH NO MODESTY PANEL

Rectangle



Tables shown this page are standard with Metronome base, locking casters, no modesty panel and 1" thick top.

Wood tables have 1/8" solid wood self edge.  
P-Lam tables have 1/8" translucent edge.

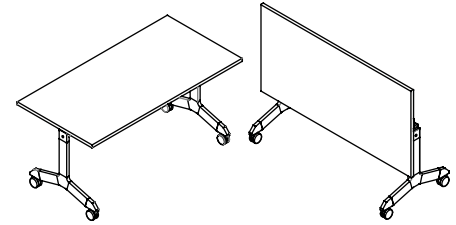

Self Edge "SE"

Note: For powder coat base, please use model # of anodized bases and add "PC" at the end, e.g. 30662PC/2.

## 1" TOP

L"	x	W"	x	H"	Top Finish	FLUSH BASES				INSET BASES			
						POLISHED		ANODIZED		POLISHED		ANODIZED	
						Model No.	List Price	Model No.	List Price	Model No.	List Price	Model No.	List Price
60		24		29	Wood	30644/2	2,970	30662/2	2,650	30680/2	2,970	30698/2	2,650
<b>60</b>		<b>24</b>		<b>29</b>	<b>P-Lam</b>	<b>30644/5</b>	<b>2,575</b>	<b>30662/5</b>	<b>2,255</b>	<b>30680/5</b>	<b>2,575</b>	<b>30698/5</b>	<b>2,255</b>
66		24		29	Wood	30645/2	3,070	30663/2	2,760	30681/2	3,070	30699/2	2,760
<b>66</b>		<b>24</b>		<b>29</b>	<b>P-Lam</b>	<b>30645/5</b>	<b>2,640</b>	<b>30663/5</b>	<b>2,315</b>	<b>30681/5</b>	<b>2,640</b>	<b>30699/5</b>	<b>2,315</b>
72		24		29	Wood	30646/2	3,170	30664/2	2,850	30682/2	3,170	30700/2	2,850
<b>72</b>		<b>24</b>		<b>29</b>	<b>P-Lam</b>	<b>30646/5</b>	<b>2,695</b>	<b>30664/5</b>	<b>2,370</b>	<b>30682/5</b>	<b>2,695</b>	<b>30700/5</b>	<b>2,370</b>
78		24		29	Wood	30647/2	3,275	30665/2	2,955	30683/2	3,275	30701/2	2,955
<b>78</b>		<b>24</b>		<b>29</b>	<b>P-Lam</b>	<b>30647/5</b>	<b>2,755</b>	<b>30665/5</b>	<b>2,425</b>	<b>30683/5</b>	<b>2,755</b>	<b>30701/5</b>	<b>2,425</b>
84		24		29	Wood	30648/2	3,370	30666/2	3,050	30684/2	3,370	30702/2	3,050
<b>84</b>		<b>24</b>		<b>29</b>	<b>P-Lam</b>	<b>30648/5</b>	<b>2,805</b>	<b>30666/5</b>	<b>2,490</b>	<b>30684/5</b>	<b>2,805</b>	<b>30702/5</b>	<b>2,490</b>
90		24		29	Wood	30649/2	3,475	30667/2	3,155	30685/2	3,475	30703/2	3,155
<b>90</b>		<b>24</b>		<b>29</b>	<b>P-Lam</b>	<b>30649/5</b>	<b>2,855</b>	<b>30667/5</b>	<b>2,535</b>	<b>30685/5</b>	<b>2,855</b>	<b>30703/5</b>	<b>2,535</b>
60		30		29	Wood	30650/2	3,175	30668/2	2,855	30686/2	3,175	30704/2	2,855
<b>60</b>		<b>30</b>		<b>29</b>	<b>P-Lam</b>	<b>30650/5</b>	<b>2,680</b>	<b>30668/5</b>	<b>2,360</b>	<b>30686/5</b>	<b>2,680</b>	<b>30704/5</b>	<b>2,360</b>
66		30		29	Wood	30651/2	3,310	30669/2	2,975	30687/2	3,310	30705/2	2,975
<b>66</b>		<b>30</b>		<b>29</b>	<b>P-Lam</b>	<b>30651/5</b>	<b>2,755</b>	<b>30669/5</b>	<b>2,425</b>	<b>30687/5</b>	<b>2,755</b>	<b>30705/5</b>	<b>2,425</b>
72		30		29	Wood	30652/2	3,425	30670/2	3,100	30688/2	3,425	30706/2	3,100
<b>72</b>		<b>30</b>		<b>29</b>	<b>P-Lam</b>	<b>30652/5</b>	<b>2,810</b>	<b>30670/5</b>	<b>2,495</b>	<b>30688/5</b>	<b>2,810</b>	<b>30706/5</b>	<b>2,495</b>
78		30		29	Wood	30653/2	3,550	30671/2	3,225	30689/2	3,550	30707/2	3,225
<b>78</b>		<b>30</b>		<b>29</b>	<b>P-Lam</b>	<b>30653/5</b>	<b>2,875</b>	<b>30671/5</b>	<b>2,550</b>	<b>30689/5</b>	<b>2,875</b>	<b>30707/5</b>	<b>2,550</b>
84		30		29	Wood	30654/2	3,665	30672/2	3,340	30690/2	3,665	30708/2	3,340
<b>84</b>		<b>30</b>		<b>29</b>	<b>P-Lam</b>	<b>30654/5</b>	<b>2,945</b>	<b>30672/5</b>	<b>2,620</b>	<b>30690/5</b>	<b>2,945</b>	<b>30708/5</b>	<b>2,620</b>
90		30		29	Wood	30655/2	3,790	30673/2	3,460	30691/2	3,790	30709/2	3,460
<b>90</b>		<b>30</b>		<b>29</b>	<b>P-Lam</b>	<b>30655/5</b>	<b>2,960</b>	<b>30673/5</b>	<b>2,640</b>	<b>30691/5</b>	<b>2,960</b>	<b>30709/5</b>	<b>2,640</b>
60		36		29	Wood	30656/2	3,355	30674/2	3,040	30692/2	3,355	30710/2	3,040
<b>60</b>		<b>36</b>		<b>29</b>	<b>P-Lam</b>	<b>30656/5</b>	<b>2,850</b>	<b>30674/5</b>	<b>2,530</b>	<b>30692/5</b>	<b>2,850</b>	<b>30710/5</b>	<b>2,530</b>
66		36		29	Wood	30657/2	3,485	30675/2	3,165	30693/2	3,485	30711/2	3,165
<b>66</b>		<b>36</b>		<b>29</b>	<b>P-Lam</b>	<b>30657/5</b>	<b>2,905</b>	<b>30675/5</b>	<b>2,585</b>	<b>30693/5</b>	<b>2,905</b>	<b>30711/5</b>	<b>2,585</b>
72		36		29	Wood	30658/2	3,665	30676/2	3,340	30694/2	3,665	30712/2	3,340
<b>72</b>		<b>36</b>		<b>29</b>	<b>P-Lam</b>	<b>30658/5</b>	<b>3,005</b>	<b>30676/5</b>	<b>2,680</b>	<b>30694/5</b>	<b>3,005</b>	<b>30712/5</b>	<b>2,680</b>
78		36		29	Wood	30659/2	3,765	30677/2	3,445	30695/2	3,765	30713/2	3,445
<b>78</b>		<b>36</b>		<b>29</b>	<b>P-Lam</b>	<b>30659/5</b>	<b>3,065</b>	<b>30677/5</b>	<b>2,755</b>	<b>30695/5</b>	<b>3,065</b>	<b>30713/5</b>	<b>2,755</b>
84		36		29	Wood	30660/2	3,870	30678/2	3,555	30696/2	3,870	30714/2	3,555
<b>84</b>		<b>36</b>		<b>29</b>	<b>P-Lam</b>	<b>30660/5</b>	<b>3,115</b>	<b>30678/5</b>	<b>2,785</b>	<b>30696/5</b>	<b>3,115</b>	<b>30714/5</b>	<b>2,785</b>
90		36		29	Wood	30661/2	4,050	30679/2	3,730	30697/2	4,050	30715/2	3,730
<b>90</b>		<b>36</b>		<b>29</b>	<b>P-Lam</b>	<b>30661/5</b>	<b>3,150</b>	<b>30679/5</b>	<b>2,820</b>	<b>30697/5</b>	<b>3,150</b>	<b>30715/5</b>	<b>2,820</b>

# METRONOME™ FLIPTOP | WITH NO MODESTY PANEL

Rectangle



Tables shown this page are standard with Metronome base, locking casters, no modesty panel and 1¼" thick top.

Wood tables have 1/8" solid wood self edge. P-Lam tables have 1/8" translucent edge. Specify edge type; add the two letter code after the model number.

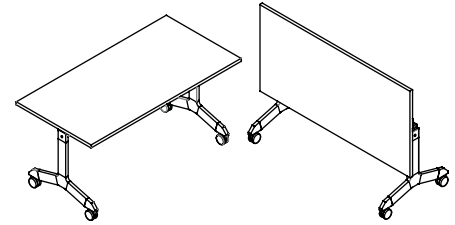

Note: For powder coat base, please use model # of anodized bases and add "PC" at the end, e.g. 30662PC/2.

## 1¼" TOP

L" x W" x H"	Top Finish	FLUSH BASES				INSET BASES					
		POLISHED		ANODIZED		POLISHED		ANODIZED			
		Model No.	List Price	Model No.	List Price	Model No.	List Price	Model No.	List Price		
60 <b>60</b>	24 <b>24</b>	29¼" <b>29¼"</b>	Wood <b>P-Lam</b>	30716/2 <b>30716/5</b>	2,880 <b>2,500</b>	30734/2 <b>30734/5</b>	2,570 <b>2,185</b>	30752/2 <b>30752/5</b>	2,880 <b>2,500</b>	30770/2 <b>30770/5</b>	2,570 <b>2,185</b>
66 <b>66</b>	24 <b>24</b>	29¼" <b>29¼"</b>	Wood <b>P-Lam</b>	30717/2 <b>30717/5</b>	2,980 <b>2,560</b>	30735/2 <b>30735/5</b>	2,675 <b>2,245</b>	30753/2 <b>30753/5</b>	2,980 <b>2,560</b>	30771/2 <b>30771/5</b>	2,675 <b>2,245</b>
72 <b>72</b>	24 <b>24</b>	29¼" <b>29¼"</b>	Wood <b>P-Lam</b>	30718/2 <b>30718/5</b>	3,075 <b>2,615</b>	30736/2 <b>30736/5</b>	2,765 <b>2,300</b>	30754/2 <b>30754/5</b>	3,075 <b>2,615</b>	30772/2 <b>30772/5</b>	2,765 <b>2,300</b>
78 <b>78</b>	24 <b>24</b>	29¼" <b>29¼"</b>	Wood <b>P-Lam</b>	30719/2 <b>30719/5</b>	3,175 <b>2,670</b>	30737/2 <b>30737/5</b>	2,865 <b>2,350</b>	30755/2 <b>30755/5</b>	3,175 <b>2,670</b>	30773/2 <b>30773/5</b>	2,865 <b>2,350</b>
84 <b>84</b>	24 <b>24</b>	29¼" <b>29¼"</b>	Wood <b>P-Lam</b>	30720/2 <b>30720/5</b>	3,270 <b>2,720</b>	30738/2 <b>30738/5</b>	2,960 <b>2,415</b>	30756/2 <b>30756/5</b>	3,270 <b>2,720</b>	30774/2 <b>30774/5</b>	2,960 <b>2,415</b>
90 <b>90</b>	24 <b>24</b>	29¼" <b>29¼"</b>	Wood <b>P-Lam</b>	30721/2 <b>30721/5</b>	3,370 <b>2,770</b>	30739/2 <b>30739/5</b>	3,060 <b>2,460</b>	30757/2 <b>30757/5</b>	3,370 <b>2,770</b>	30775/2 <b>30775/5</b>	3,060 <b>2,460</b>
60 <b>60</b>	30 <b>30</b>	29¼" <b>29¼"</b>	Wood <b>P-Lam</b>	30722/2 <b>30722/5</b>	3,080 <b>2,600</b>	30740/2 <b>30740/5</b>	2,770 <b>2,290</b>	30758/2 <b>30758/5</b>	3,080 <b>2,600</b>	30776/2 <b>30776/5</b>	2,770 <b>2,290</b>
66 <b>66</b>	30 <b>30</b>	29¼" <b>29¼"</b>	Wood <b>P-Lam</b>	30723/2 <b>30723/5</b>	3,210 <b>2,670</b>	30741/2 <b>30741/5</b>	2,885 <b>2,350</b>	30759/2 <b>30759/5</b>	3,210 <b>2,670</b>	30777/2 <b>30777/5</b>	2,885 <b>2,350</b>
72 <b>72</b>	30 <b>30</b>	29¼" <b>29¼"</b>	Wood <b>P-Lam</b>	30724/2 <b>30724/5</b>	3,325 <b>2,725</b>	30742/2 <b>30742/5</b>	3,005 <b>2,420</b>	30760/2 <b>30760/5</b>	3,325 <b>2,725</b>	30778/2 <b>30778/5</b>	3,005 <b>2,420</b>
78 <b>78</b>	30 <b>30</b>	29¼" <b>29¼"</b>	Wood <b>P-Lam</b>	30725/2 <b>30725/5</b>	3,445 <b>2,790</b>	30743/2 <b>30743/5</b>	3,130 <b>2,475</b>	30761/2 <b>30761/5</b>	3,445 <b>2,790</b>	30779/2 <b>30779/5</b>	3,130 <b>2,475</b>
84 <b>84</b>	30 <b>30</b>	29¼" <b>29¼"</b>	Wood <b>P-Lam</b>	30726/2 <b>30726/5</b>	3,555 <b>2,855</b>	30744/2 <b>30744/5</b>	3,240 <b>2,540</b>	30762/2 <b>30762/5</b>	3,555 <b>2,855</b>	30780/2 <b>30780/5</b>	3,240 <b>2,540</b>
90 <b>90</b>	30 <b>30</b>	29¼" <b>29¼"</b>	Wood <b>P-Lam</b>	30727/2 <b>30727/5</b>	3,675 <b>2,870</b>	30745/2 <b>30745/5</b>	3,355 <b>2,560</b>	30763/2 <b>30763/5</b>	3,675 <b>2,870</b>	30781/2 <b>30781/5</b>	3,355 <b>2,560</b>
60 <b>60</b>	36 <b>36</b>	29¼" <b>29¼"</b>	Wood <b>P-Lam</b>	30728/2 <b>30728/5</b>	3,255 <b>2,765</b>	30746/2 <b>30746/5</b>	2,950 <b>2,455</b>	30764/2 <b>30764/5</b>	3,255 <b>2,765</b>	30782/2 <b>30782/5</b>	2,950 <b>2,455</b>
66 <b>66</b>	36 <b>36</b>	29¼" <b>29¼"</b>	Wood <b>P-Lam</b>	30729/2 <b>30729/5</b>	3,380 <b>2,820</b>	30747/2 <b>30747/5</b>	3,070 <b>2,505</b>	30765/2 <b>30765/5</b>	3,380 <b>2,820</b>	30783/2 <b>30783/5</b>	3,070 <b>2,505</b>
72 <b>72</b>	36 <b>36</b>	29¼" <b>29¼"</b>	Wood <b>P-Lam</b>	30730/2 <b>30730/5</b>	3,555 <b>2,915</b>	30748/2 <b>30748/5</b>	3,240 <b>2,600</b>	30766/2 <b>30766/5</b>	3,555 <b>2,915</b>	30784/2 <b>30784/5</b>	3,240 <b>2,600</b>
78 <b>78</b>	36 <b>36</b>	29¼" <b>29¼"</b>	Wood <b>P-Lam</b>	30731/2 <b>30731/5</b>	3,655 <b>2,975</b>	30749/2 <b>30749/5</b>	3,340 <b>2,670</b>	30767/2 <b>30767/5</b>	3,655 <b>2,975</b>	30785/2 <b>30785/5</b>	3,340 <b>2,670</b>
84 <b>84</b>	36 <b>36</b>	29¼" <b>29¼"</b>	Wood <b>P-Lam</b>	30732/2 <b>30732/5</b>	3,755 <b>3,020</b>	30750/2 <b>30750/5</b>	3,450 <b>2,700</b>	30768/2 <b>30768/5</b>	3,755 <b>3,020</b>	30786/2 <b>30786/5</b>	3,450 <b>2,700</b>
90 <b>90</b>	36 <b>36</b>	29¼" <b>29¼"</b>	Wood <b>P-Lam</b>	30733/2 <b>30733/5</b>	3,930 <b>3,055</b>	30751/2 <b>30751/5</b>	3,620 <b>2,735</b>	30769/2 <b>30769/5</b>	3,930 <b>3,055</b>	30787/2 <b>30787/5</b>	3,620 <b>2,735</b>



# METRONOME™ FLIPTOP | WITH MODESTY PANEL

Rectangle



Tables shown this page are standard with Metronome base, locking casters, 5" tall modesty panel in matching finish and 1" thick top.

Wood tables have 1/8" solid wood self edge.  
P-Lam tables have 1/8" translucent edge.

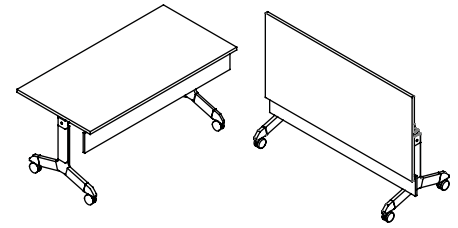

Self Edge "SE"

Note: For powder coat base, please use model # of anodized bases and add "PC" at the end, e.g. 30662PC/2.

## 1" TOP

L" x W" x H"	Top Finish	FLUSH BASES				INSET BASES					
		POLISHED		ANODIZED		POLISHED		ANODIZED			
		Model No.	List Price	Model No.	List Price	Model No.	List Price	Model No.	List Price		
60 <b>60</b>	24 <b>24</b>	29 <b>29</b>	Wood <b>P-Lam</b>	30500/2 <b>30500/5</b>	3,460 <b>2,950</b>	30518/2 <b>30518/5</b>	3,145 <b>2,625</b>	30536/2 <b>30536/5</b>	3,460 <b>2,950</b>	30554/2 <b>30554/5</b>	3,145 <b>2,625</b>
66 <b>66</b>	24 <b>24</b>	29 <b>29</b>	Wood <b>P-Lam</b>	30501/2 <b>30501/5</b>	3,615 <b>3,055</b>	30519/2 <b>30519/5</b>	3,285 <b>2,730</b>	30537/2 <b>30537/5</b>	3,615 <b>3,055</b>	30555/2 <b>30555/5</b>	3,285 <b>2,730</b>
72 <b>72</b>	24 <b>24</b>	29 <b>29</b>	Wood <b>P-Lam</b>	30502/2 <b>30502/5</b>	3,755 <b>3,150</b>	30520/2 <b>30520/5</b>	3,440 <b>2,820</b>	30538/2 <b>30538/5</b>	3,755 <b>3,150</b>	30556/2 <b>30556/5</b>	3,440 <b>2,820</b>
78 <b>78</b>	24 <b>24</b>	29 <b>29</b>	Wood <b>P-Lam</b>	30503/2 <b>30503/5</b>	3,935 <b>3,260</b>	30521/2 <b>30521/5</b>	3,615 <b>2,945</b>	30539/2 <b>30539/5</b>	3,935 <b>3,260</b>	30557/2 <b>30557/5</b>	3,615 <b>2,945</b>
84 <b>84</b>	24 <b>24</b>	29 <b>29</b>	Wood <b>P-Lam</b>	30504/2 <b>30504/5</b>	4,095 <b>3,360</b>	30522/2 <b>30522/5</b>	3,775 <b>3,045</b>	30540/2 <b>30540/5</b>	4,095 <b>3,360</b>	30558/2 <b>30558/5</b>	3,775 <b>3,045</b>
90 <b>90</b>	24 <b>24</b>	29 <b>29</b>	Wood <b>P-Lam</b>	30505/2 <b>30505/5</b>	4,260 <b>3,465</b>	30523/2 <b>30523/5</b>	3,940 <b>3,150</b>	30541/2 <b>30541/5</b>	4,260 <b>3,465</b>	30559/2 <b>30559/5</b>	3,940 <b>3,150</b>
60 <b>60</b>	30 <b>30</b>	29 <b>29</b>	Wood <b>P-Lam</b>	30506/2 <b>30506/5</b>	3,670 <b>3,045</b>	30524/2 <b>30524/5</b>	3,345 <b>2,720</b>	30542/2 <b>30542/5</b>	3,670 <b>3,045</b>	30560/2 <b>30560/5</b>	3,345 <b>2,720</b>
66 <b>66</b>	30 <b>30</b>	29 <b>29</b>	Wood <b>P-Lam</b>	30507/2 <b>30507/5</b>	3,840 <b>3,160</b>	30525/2 <b>30525/5</b>	3,520 <b>2,840</b>	30543/2 <b>30543/5</b>	3,840 <b>3,160</b>	30561/2 <b>30561/5</b>	3,520 <b>2,840</b>
72 <b>72</b>	30 <b>30</b>	29 <b>29</b>	Wood <b>P-Lam</b>	30508/2 <b>30508/5</b>	4,005 <b>3,260</b>	30526/2 <b>30526/5</b>	3,680 <b>2,945</b>	30544/2 <b>30544/5</b>	4,005 <b>3,260</b>	30562/2 <b>30562/5</b>	3,680 <b>2,945</b>
78 <b>78</b>	30 <b>30</b>	29 <b>29</b>	Wood <b>P-Lam</b>	30509/2 <b>30509/5</b>	4,210 <b>3,395</b>	30527/2 <b>30527/5</b>	3,880 <b>3,065</b>	30545/2 <b>30545/5</b>	4,210 <b>3,395</b>	30563/2 <b>30563/5</b>	3,880 <b>3,065</b>
84 <b>84</b>	30 <b>30</b>	29 <b>29</b>	Wood <b>P-Lam</b>	30510/2 <b>30510/5</b>	4,390 <b>3,500</b>	30528/2 <b>30528/5</b>	4,065 <b>3,175</b>	30546/2 <b>30546/5</b>	4,390 <b>3,500</b>	30564/2 <b>30564/5</b>	4,065 <b>3,175</b>
90 <b>90</b>	30 <b>30</b>	29 <b>29</b>	Wood <b>P-Lam</b>	30511/2 <b>30511/5</b>	4,580 <b>3,570</b>	30529/2 <b>30529/5</b>	4,255 <b>3,245</b>	30547/2 <b>30547/5</b>	4,580 <b>3,570</b>	30565/2 <b>30565/5</b>	4,255 <b>3,245</b>
60 <b>60</b>	36 <b>36</b>	29 <b>29</b>	Wood <b>P-Lam</b>	30512/2 <b>30512/5</b>	3,885 <b>3,235</b>	30530/2 <b>30530/5</b>	3,565 <b>2,915</b>	30548/2 <b>30548/5</b>	3,885 <b>3,235</b>	30566/2 <b>30566/5</b>	3,565 <b>2,915</b>
66 <b>66</b>	36 <b>36</b>	29 <b>29</b>	Wood <b>P-Lam</b>	30513/2 <b>30513/5</b>	4,085 <b>3,345</b>	30531/2 <b>30531/5</b>	3,755 <b>3,030</b>	30549/2 <b>30549/5</b>	4,085 <b>3,345</b>	30567/2 <b>30567/5</b>	3,755 <b>3,030</b>
72 <b>72</b>	36 <b>36</b>	29 <b>29</b>	Wood <b>P-Lam</b>	30514/2 <b>30514/5</b>	4,280 <b>3,500</b>	30532/2 <b>30532/5</b>	3,965 <b>3,175</b>	30550/2 <b>30550/5</b>	4,280 <b>3,500</b>	30568/2 <b>30568/5</b>	3,965 <b>3,175</b>
78 <b>78</b>	36 <b>36</b>	29 <b>29</b>	Wood <b>P-Lam</b>	30515/2 <b>30515/5</b>	4,580 <b>3,570</b>	30533/2 <b>30533/5</b>	4,255 <b>3,245</b>	30551/2 <b>30551/5</b>	4,580 <b>3,570</b>	30569/2 <b>30569/5</b>	4,255 <b>3,245</b>
84 <b>84</b>	36 <b>36</b>	29 <b>29</b>	Wood <b>P-Lam</b>	30516/2 <b>30516/5</b>	4,695 <b>3,675</b>	30534/2 <b>30534/5</b>	4,370 <b>3,350</b>	30552/2 <b>30552/5</b>	4,695 <b>3,675</b>	30570/2 <b>30570/5</b>	4,370 <b>3,350</b>
90 <b>90</b>	36 <b>36</b>	29 <b>29</b>	Wood <b>P-Lam</b>	30517/2 <b>30517/5</b>	4,895 <b>3,785</b>	30535/2 <b>30535/5</b>	4,575 <b>3,455</b>	30553/2 <b>30553/5</b>	4,895 <b>3,785</b>	30571/2 <b>30571/5</b>	4,575 <b>3,455</b>



Tables shown this page are standard with Metronome base, locking casters, 5" tall modesty panel in matching finish and 1 1/4" thick top.

Wood tables have 1/8" solid wood self edge. P-Lam tables have 1/8" translucent edge. Specify edge type; add the two letter code after the model number.

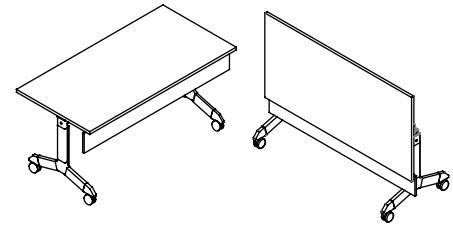

Note: For powder coat base, please use model # of anodized bases and add "PC" at the end, e.g. 30662PC/2.

**1 1/4" TOP**

L" x W" x H"	Top Finish	FLUSH BASES				INSET BASES					
		POLISHED		ANODIZED		POLISHED		ANODIZED			
		Model No.	List Price	Model No.	List Price	Model No.	List Price	Model No.	List Price		
60 <b>60</b>	24 <b>24</b>	29 1/4 <b>29 1/4</b>	Wood <b>P-Lam</b>	30572/2 <b>30572/5</b>	3,460 <b>2,950</b>	30590/2 <b>30590/5</b>	3,145 <b>2,625</b>	30608/2 <b>30608/5</b>	3,460 <b>2,950</b>	30626/2 <b>30626/5</b>	3,145 <b>2,625</b>
66 <b>66</b>	24 <b>24</b>	29 1/4 <b>29 1/4</b>	Wood <b>P-Lam</b>	30573/2 <b>30573/5</b>	3,615 <b>3,055</b>	30591/2 <b>30591/5</b>	3,285 <b>2,730</b>	30609/2 <b>30609/5</b>	3,615 <b>3,055</b>	30627/2 <b>30627/5</b>	3,285 <b>2,730</b>
72 <b>72</b>	24 <b>24</b>	29 1/4 <b>29 1/4</b>	Wood <b>P-Lam</b>	30574/2 <b>30574/5</b>	3,755 <b>3,150</b>	30592/2 <b>30592/5</b>	3,440 <b>2,820</b>	30610/2 <b>30610/5</b>	3,755 <b>3,150</b>	30628/2 <b>30628/5</b>	3,440 <b>2,820</b>
78 <b>78</b>	24 <b>24</b>	29 1/4 <b>29 1/4</b>	Wood <b>P-Lam</b>	30575/2 <b>30575/5</b>	3,935 <b>3,260</b>	30593/2 <b>30593/5</b>	3,615 <b>2,945</b>	30611/2 <b>30611/5</b>	3,935 <b>3,260</b>	30629/2 <b>30629/5</b>	3,615 <b>2,945</b>
84 <b>84</b>	24 <b>24</b>	29 1/4 <b>29 1/4</b>	Wood <b>P-Lam</b>	30576/2 <b>30576/5</b>	4,095 <b>3,360</b>	30594/2 <b>30594/5</b>	3,775 <b>3,045</b>	30612/2 <b>30612/5</b>	4,095 <b>3,360</b>	30630/2 <b>30630/5</b>	3,775 <b>3,045</b>
90 <b>90</b>	24 <b>24</b>	29 1/4 <b>29 1/4</b>	Wood <b>P-Lam</b>	30577/2 <b>30577/5</b>	4,260 <b>3,465</b>	30595/2 <b>30595/5</b>	3,940 <b>3,150</b>	30613/2 <b>30613/5</b>	4,260 <b>3,465</b>	30631/2 <b>30631/5</b>	3,940 <b>3,150</b>
60 <b>60</b>	30 <b>30</b>	29 1/4 <b>29 1/4</b>	Wood <b>P-Lam</b>	30578/2 <b>30578/5</b>	3,670 <b>3,045</b>	30596/2 <b>30596/5</b>	3,345 <b>2,720</b>	30614/2 <b>30614/5</b>	3,670 <b>3,045</b>	30632/2 <b>30632/5</b>	3,345 <b>2,720</b>
66 <b>66</b>	30 <b>30</b>	29 1/4 <b>29 1/4</b>	Wood <b>P-Lam</b>	30579/2 <b>30579/5</b>	3,840 <b>3,160</b>	30597/2 <b>30597/5</b>	3,520 <b>2,840</b>	30615/2 <b>30615/5</b>	3,840 <b>3,160</b>	30633/2 <b>30633/5</b>	3,520 <b>2,840</b>
72 <b>72</b>	30 <b>30</b>	29 1/4 <b>29 1/4</b>	Wood <b>P-Lam</b>	30580/2 <b>30580/5</b>	4,005 <b>3,260</b>	30598/2 <b>30598/5</b>	3,680 <b>2,945</b>	30616/2 <b>30616/5</b>	4,005 <b>3,260</b>	30634/2 <b>30634/5</b>	3,680 <b>2,945</b>
78 <b>78</b>	30 <b>30</b>	29 1/4 <b>29 1/4</b>	Wood <b>P-Lam</b>	30581/2 <b>30581/5</b>	4,210 <b>3,395</b>	30599/2 <b>30599/5</b>	3,880 <b>3,065</b>	30617/2 <b>30617/5</b>	4,210 <b>3,395</b>	30635/2 <b>30635/5</b>	3,880 <b>3,065</b>
84 <b>84</b>	30 <b>30</b>	29 1/4 <b>29 1/4</b>	Wood <b>P-Lam</b>	30582/2 <b>30582/5</b>	4,390 <b>3,500</b>	30600/2 <b>30600/5</b>	4,065 <b>3,175</b>	30618/2 <b>30618/5</b>	4,390 <b>3,500</b>	30636/2 <b>30636/5</b>	4,065 <b>3,175</b>
90 <b>90</b>	30 <b>30</b>	29 1/4 <b>29 1/4</b>	Wood <b>P-Lam</b>	30583/2 <b>30583/5</b>	4,580 <b>3,570</b>	30601/2 <b>30601/5</b>	4,255 <b>3,245</b>	30619/2 <b>30619/5</b>	4,580 <b>3,570</b>	30637/2 <b>30637/5</b>	4,255 <b>3,245</b>
60 <b>60</b>	36 <b>36</b>	29 1/4 <b>29 1/4</b>	Wood <b>P-Lam</b>	30584/2 <b>30584/5</b>	3,885 <b>3,235</b>	30602/2 <b>30602/5</b>	3,565 <b>2,915</b>	30620/2 <b>30620/5</b>	3,885 <b>3,235</b>	30638/2 <b>30638/5</b>	3,565 <b>2,915</b>
66 <b>66</b>	36 <b>36</b>	29 1/4 <b>29 1/4</b>	Wood <b>P-Lam</b>	30585/2 <b>30585/5</b>	4,085 <b>3,345</b>	30603/2 <b>30603/5</b>	3,755 <b>3,030</b>	30621/2 <b>30621/5</b>	4,085 <b>3,345</b>	30639/2 <b>30639/5</b>	3,755 <b>3,030</b>
72 <b>72</b>	36 <b>36</b>	29 1/4 <b>29 1/4</b>	Wood <b>P-Lam</b>	30586/2 <b>30586/5</b>	4,280 <b>3,500</b>	30604/2 <b>30604/5</b>	3,965 <b>3,175</b>	30622/2 <b>30622/5</b>	4,280 <b>3,500</b>	30640/2 <b>30640/5</b>	3,965 <b>3,175</b>
78 <b>78</b>	36 <b>36</b>	29 1/4 <b>29 1/4</b>	Wood <b>P-Lam</b>	30587/2 <b>30587/5</b>	4,580 <b>3,570</b>	30605/2 <b>30605/5</b>	4,255 <b>3,245</b>	30623/2 <b>30623/5</b>	4,580 <b>3,570</b>	30641/2 <b>30641/5</b>	4,255 <b>3,245</b>
84 <b>84</b>	36 <b>36</b>	29 1/4 <b>29 1/4</b>	Wood <b>P-Lam</b>	30588/2 <b>30588/5</b>	4,695 <b>3,675</b>	30606/2 <b>30606/5</b>	4,370 <b>3,350</b>	30624/2 <b>30624/5</b>	4,695 <b>3,675</b>	30642/2 <b>30642/5</b>	4,370 <b>3,350</b>
90 <b>90</b>	36 <b>36</b>	29 1/4 <b>29 1/4</b>	Wood <b>P-Lam</b>	30589/2 <b>30589/5</b>	4,895 <b>3,785</b>	30607/2 <b>30607/5</b>	4,575 <b>3,455</b>	30625/2 <b>30625/5</b>	4,895 <b>3,785</b>	30643/2 <b>30643/5</b>	4,575 <b>3,455</b>

# METRONOME™ FLIPTOP | WITH NO MODESTY PANEL

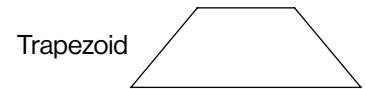

Tables shown this page are standard with Metronome base, locking casters. Top is 1" thick for self edge and 1¼" thick for profile edges.

Wood tables have 1/8" solid wood self edge. P-Lam tables have 1/8" translucent edge. Specify edge type; add the two letter code after the model number.



Self Edge "SE"



Taper Edge "TE" on user side only



Facet Edge "FC" on user side only



Flow Form Edge "FF" on user side only 5% upcharge laminate not available

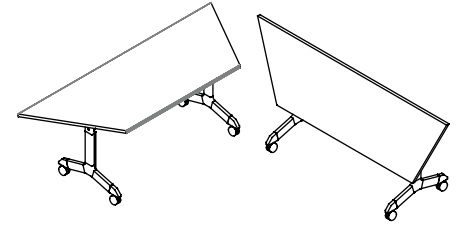

Note: For powder coat base, please use model # of anodized bases and add "PC" at the end, e.g. 30662PC/2.

				1" TOP (SELF EDGE)				1¼" TOP (TAPER, FACET, FLOW FORM EDGE)			
				POLISHED		ANODIZED		POLISHED		ANODIZED	
L" x W" x H"	Top Finish	Model No.	List Price	Model No.	List Price	Model No.	List Price	Model No.	List Price	Model No.	List Price
60 x 24 x 29	Wood	30824/2	3,235	30842/2	2,915	30896/2	3,235	30914/2	2,915		
<b>60 x 24 x 29</b>	<b>P-Lam</b>	<b>30824/5</b>	<b>2,805</b>	<b>30842/5</b>	<b>2,490</b>	<b>30896/5</b>	<b>2,805</b>	<b>30914/5</b>	<b>2,490</b>		
66 x 24 x 29	Wood	30825/2	3,350	30843/2	3,035	30897/2	3,350	30915/2	3,035		
<b>66 x 24 x 29</b>	<b>P-Lam</b>	<b>30825/5</b>	<b>2,870</b>	<b>30843/5</b>	<b>2,545</b>	<b>30897/5</b>	<b>2,870</b>	<b>30915/5</b>	<b>2,545</b>		
72 x 24 x 29	Wood	30826/2	3,455	30844/2	3,140	30898/2	3,455	30916/2	3,140		
<b>72 x 24 x 29</b>	<b>P-Lam</b>	<b>30826/5</b>	<b>2,940</b>	<b>30844/5</b>	<b>2,615</b>	<b>30898/5</b>	<b>2,940</b>	<b>30916/5</b>	<b>2,615</b>		
78 x 24 x 29	Wood	30827/2	3,570	30845/2	3,245	30899/2	3,570	30917/2	3,245		
<b>78 x 24 x 29</b>	<b>P-Lam</b>	<b>30827/5</b>	<b>2,985</b>	<b>30845/5</b>	<b>2,670</b>	<b>30899/5</b>	<b>2,985</b>	<b>30917/5</b>	<b>2,670</b>		
84 x 24 x 29	Wood	30828/2	3,675	30846/2	3,350	30900/2	3,675	30918/2	3,350		
<b>84 x 24 x 29</b>	<b>P-Lam</b>	<b>30828/5</b>	<b>3,055</b>	<b>30846/5</b>	<b>2,730</b>	<b>30900/5</b>	<b>3,055</b>	<b>30918/5</b>	<b>2,730</b>		
90 x 24 x 29	Wood	30829/2	3,795	30847/2	3,465	30901/2	3,795	30919/2	3,465		
<b>90 x 24 x 29</b>	<b>P-Lam</b>	<b>30829/5</b>	<b>3,115</b>	<b>30847/5</b>	<b>2,785</b>	<b>30901/5</b>	<b>3,115</b>	<b>30919/5</b>	<b>2,785</b>		
60 x 30 x 29	Wood	30830/2	3,460	30848/2	3,145	30902/2	3,460	30920/2	3,145		
<b>60 x 30 x 29</b>	<b>P-Lam</b>	<b>30830/5</b>	<b>2,930</b>	<b>30848/5</b>	<b>2,595</b>	<b>30902/5</b>	<b>2,930</b>	<b>30920/5</b>	<b>2,595</b>		
66 x 30 x 29	Wood	30831/2	3,585	30849/2	3,260	30903/2	3,585	30921/2	3,260		
<b>66 x 30 x 29</b>	<b>P-Lam</b>	<b>30831/5</b>	<b>2,985</b>	<b>30849/5</b>	<b>2,670</b>	<b>30903/5</b>	<b>2,985</b>	<b>30921/5</b>	<b>2,670</b>		
72 x 30 x 29	Wood	30832/2	3,735	30850/2	3,415	30904/2	3,735	30922/2	3,415		
<b>72 x 30 x 29</b>	<b>P-Lam</b>	<b>30832/5</b>	<b>3,060</b>	<b>30850/5</b>	<b>2,745</b>	<b>30904/5</b>	<b>3,060</b>	<b>30922/5</b>	<b>2,745</b>		
78 x 30 x 29	Wood	30833/2	3,865	30851/2	3,550	30905/2	3,865	30923/2	3,550		
<b>78 x 30 x 29</b>	<b>P-Lam</b>	<b>30833/5</b>	<b>3,140</b>	<b>30851/5</b>	<b>2,810</b>	<b>30905/5</b>	<b>3,140</b>	<b>30923/5</b>	<b>2,810</b>		
84 x 30 x 29	Wood	30834/2	4,000	30852/2	3,675	30906/2	4,000	30924/2	3,675		
<b>84 x 30 x 29</b>	<b>P-Lam</b>	<b>30834/5</b>	<b>3,210</b>	<b>30852/5</b>	<b>2,880</b>	<b>30906/5</b>	<b>3,210</b>	<b>30924/5</b>	<b>2,880</b>		
90 x 30 x 29	Wood	30835/2	4,135	30853/2	3,815	30907/2	4,135	30925/2	3,815		
<b>90 x 30 x 29</b>	<b>P-Lam</b>	<b>30835/5</b>	<b>3,225</b>	<b>30853/5</b>	<b>2,900</b>	<b>30907/5</b>	<b>3,225</b>	<b>30925/5</b>	<b>2,900</b>		
60 x 36 x 29	Wood	30836/2	3,665	30854/2	3,340	30908/2	3,665	30926/2	3,340		
<b>60 x 36 x 29</b>	<b>P-Lam</b>	<b>30836/5</b>	<b>3,100</b>	<b>30854/5</b>	<b>2,780</b>	<b>30908/5</b>	<b>3,100</b>	<b>30926/5</b>	<b>2,780</b>		
66 x 36 x 29	Wood	30837/2	3,810	30855/2	3,480	30909/2	3,810	30927/2	3,480		
<b>66 x 36 x 29</b>	<b>P-Lam</b>	<b>30837/5</b>	<b>3,165</b>	<b>30855/5</b>	<b>2,845</b>	<b>30909/5</b>	<b>3,165</b>	<b>30927/5</b>	<b>2,845</b>		
72 x 36 x 29	Wood	30838/2	4,000	30856/2	3,675	30910/2	4,000	30928/2	3,675		
<b>72 x 36 x 29</b>	<b>P-Lam</b>	<b>30838/5</b>	<b>3,275</b>	<b>30856/5</b>	<b>2,955</b>	<b>30910/5</b>	<b>3,275</b>	<b>30928/5</b>	<b>2,955</b>		
78 x 36 x 29	Wood	30839/2	4,105	30857/2	3,790	30911/2	4,105	30929/2	3,790		
<b>78 x 36 x 29</b>	<b>P-Lam</b>	<b>30839/5</b>	<b>3,345</b>	<b>30857/5</b>	<b>3,030</b>	<b>30911/5</b>	<b>3,345</b>	<b>30929/5</b>	<b>3,030</b>		
84 x 36 x 29	Wood	30840/2	4,230	30858/2	3,910	30912/2	4,230	30930/2	3,910		
<b>84 x 36 x 29</b>	<b>P-Lam</b>	<b>30840/5</b>	<b>3,385</b>	<b>30858/5</b>	<b>3,060</b>	<b>30912/5</b>	<b>3,385</b>	<b>30930/5</b>	<b>3,060</b>		
90 x 36 x 29	Wood	30841/2	4,430	30859/2	4,100	30913/2	4,430	30931/2	4,100		
<b>90 x 36 x 29</b>	<b>P-Lam</b>	<b>30841/5</b>	<b>3,430</b>	<b>30859/5</b>	<b>3,115</b>	<b>30913/5</b>	<b>3,430</b>	<b>30931/5</b>	<b>3,115</b>		

# METRONOME™ FLIPTOP | WITH MODESTY PANEL

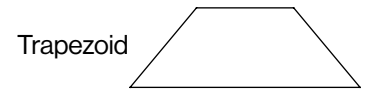

Tables shown this page are standard with Metronome base, locking casters, 5" tall modesty panel in matching finish and 1 1/4" thick top.

Wood tables have 1/8" solid wood self edge. P-Lam tables have 1/8" translucent edge. Specify edge type; add the two letter code after the model number.



Self Edge "SE"



Taper Edge "TE" on user side only



Facet Edge "FC" on user side only



Flow Form Edge "FF" on user side only 5% upcharge laminate not available

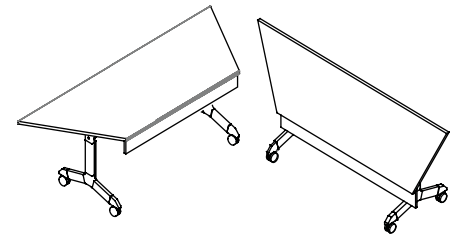

Note: For powder coat base, please use model # of anodized bases and add "PC" at the end, e.g. 30662PC/2.

				1" TOP (SELF EDGE)				1 1/4" TOP (TAPER, FACET, FLOW FORM EDGE)			
				POLISHED		ANODIZED		POLISHED		ANODIZED	
L" x W" x H"	Top Finish	Model No.	List Price	Model No.	List Price	Model No.	List Price	Model No.	List Price	Model No.	List Price
60 x 24 x 29	Wood	30788/2	3,785	30806/2	3,455	30860/2	3,785	30878/2	3,455		
<b>60 x 24 x 29</b>	<b>P-Lam</b>	<b>30788/5</b>	<b>3,215</b>	<b>30806/5</b>	<b>2,890</b>	<b>30860/5</b>	<b>3,215</b>	<b>30878/5</b>	<b>2,890</b>		
66 x 24 x 29	Wood	30789/2	3,940	30807/2	3,620	30861/2	3,940	30879/2	3,620		
<b>66 x 24 x 29</b>	<b>P-Lam</b>	<b>30789/5</b>	<b>3,330</b>	<b>30807/5</b>	<b>3,005</b>	<b>30861/5</b>	<b>3,330</b>	<b>30879/5</b>	<b>3,005</b>		
72 x 24 x 29	Wood	30790/2	4,100	30808/2	3,785	30862/2	4,100	30880/2	3,785		
<b>72 x 24 x 29</b>	<b>P-Lam</b>	<b>30790/5</b>	<b>3,430</b>	<b>30808/5</b>	<b>3,115</b>	<b>30862/5</b>	<b>3,430</b>	<b>30880/5</b>	<b>3,115</b>		
78 x 24 x 29	Wood	30791/2	4,300	30809/2	3,975	30863/2	4,300	30881/2	3,975		
<b>78 x 24 x 29</b>	<b>P-Lam</b>	<b>30791/5</b>	<b>3,560</b>	<b>30809/5</b>	<b>3,235</b>	<b>30863/5</b>	<b>3,560</b>	<b>30881/5</b>	<b>3,235</b>		
84 x 24 x 29	Wood	30792/2	4,475	30810/2	4,150	30864/2	4,475	30882/2	4,150		
<b>84 x 24 x 29</b>	<b>P-Lam</b>	<b>30792/5</b>	<b>3,670</b>	<b>30810/5</b>	<b>3,345</b>	<b>30864/5</b>	<b>3,670</b>	<b>30882/5</b>	<b>3,345</b>		
90 x 24 x 29	Wood	30793/2	4,660	30811/2	4,340	30865/2	4,660	30883/2	4,340		
<b>90 x 24 x 29</b>	<b>P-Lam</b>	<b>30793/5</b>	<b>3,790</b>	<b>30811/5</b>	<b>3,460</b>	<b>30865/5</b>	<b>3,790</b>	<b>30883/5</b>	<b>3,460</b>		
60 x 30 x 29	Wood	30794/2	4,005	30812/2	3,680	30866/2	4,005	30884/2	3,680		
<b>60 x 30 x 29</b>	<b>P-Lam</b>	<b>30794/5</b>	<b>3,320</b>	<b>30812/5</b>	<b>2,985</b>	<b>30866/5</b>	<b>3,320</b>	<b>30884/5</b>	<b>2,985</b>		
66 x 30 x 29	Wood	30795/2	4,185	30813/2	3,860	30867/2	4,185	30885/2	3,860		
<b>66 x 30 x 29</b>	<b>P-Lam</b>	<b>30795/5</b>	<b>3,445</b>	<b>30813/5</b>	<b>3,125</b>	<b>30867/5</b>	<b>3,445</b>	<b>30885/5</b>	<b>3,125</b>		
72 x 30 x 29	Wood	30796/2	4,370	30814/2	4,050	30868/2	4,370	30886/2	4,050		
<b>72 x 30 x 29</b>	<b>P-Lam</b>	<b>30796/5</b>	<b>3,560</b>	<b>30814/5</b>	<b>3,235</b>	<b>30868/5</b>	<b>3,560</b>	<b>30886/5</b>	<b>3,235</b>		
78 x 30 x 29	Wood	30797/2	4,595	30815/2	4,270	30869/2	4,595	30887/2	4,270		
<b>78 x 30 x 29</b>	<b>P-Lam</b>	<b>30797/5</b>	<b>3,700</b>	<b>30815/5</b>	<b>3,375</b>	<b>30869/5</b>	<b>3,700</b>	<b>30887/5</b>	<b>3,375</b>		
84 x 30 x 29	Wood	30798/2	4,800	30816/2	4,480	30870/2	4,800	30888/2	4,480		
<b>84 x 30 x 29</b>	<b>P-Lam</b>	<b>30798/5</b>	<b>3,820</b>	<b>30816/5</b>	<b>3,490</b>	<b>30870/5</b>	<b>3,820</b>	<b>30888/5</b>	<b>3,490</b>		
90 x 30 x 29	Wood	30799/2	5,010	30817/2	4,685	30871/2	5,010	30889/2	4,685		
<b>90 x 30 x 29</b>	<b>P-Lam</b>	<b>30799/5</b>	<b>3,890</b>	<b>30817/5</b>	<b>3,570</b>	<b>30871/5</b>	<b>3,890</b>	<b>30889/5</b>	<b>3,570</b>		
60 x 36 x 29	Wood	30800/2	4,240	30818/2	3,925	30872/2	4,240	30890/2	3,925		
<b>60 x 36 x 29</b>	<b>P-Lam</b>	<b>30800/5</b>	<b>3,530</b>	<b>30818/5</b>	<b>3,210</b>	<b>30872/5</b>	<b>3,530</b>	<b>30890/5</b>	<b>3,210</b>		
66 x 36 x 29	Wood	30801/2	4,460	30819/2	4,135	30873/2	4,460	30891/2	4,135		
<b>66 x 36 x 29</b>	<b>P-Lam</b>	<b>30801/5</b>	<b>3,655</b>	<b>30819/5</b>	<b>3,330</b>	<b>30873/5</b>	<b>3,655</b>	<b>30891/5</b>	<b>3,330</b>		
72 x 36 x 29	Wood	30802/2	4,680	30820/2	4,355	30874/2	4,680	30892/2	4,355		
<b>72 x 36 x 29</b>	<b>P-Lam</b>	<b>30802/5</b>	<b>3,820</b>	<b>30820/5</b>	<b>3,490</b>	<b>30874/5</b>	<b>3,820</b>	<b>30892/5</b>	<b>3,490</b>		
78 x 36 x 29	Wood	30803/2	5,010	30821/2	4,685	30875/2	5,010	30893/2	4,685		
<b>78 x 36 x 29</b>	<b>P-Lam</b>	<b>30803/5</b>	<b>3,890</b>	<b>30821/5</b>	<b>3,570</b>	<b>30875/5</b>	<b>3,890</b>	<b>30893/5</b>	<b>3,570</b>		
84 x 36 x 29	Wood	30804/2	5,135	30822/2	4,820	30876/2	5,135	30894/2	4,820		
<b>84 x 36 x 29</b>	<b>P-Lam</b>	<b>30804/5</b>	<b>4,010</b>	<b>30822/5</b>	<b>3,690</b>	<b>30876/5</b>	<b>4,010</b>	<b>30894/5</b>	<b>3,690</b>		
90 x 36 x 29	Wood	30805/2	5,360	30823/2	5,030	30877/2	5,360	30895/2	5,030		
<b>90 x 36 x 29</b>	<b>P-Lam</b>	<b>30805/5</b>	<b>4,130</b>	<b>30823/5</b>	<b>3,810</b>	<b>30877/5</b>	<b>4,130</b>	<b>30895/5</b>	<b>3,810</b>		

# METRONOME™ FLIPTOP | WITH NO MODESTY PANEL

Multi-angle

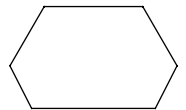

Tables shown this page are standard with Metronome base, locking casters. Top is 1" thick for self edge and 1¼" thick for profile edges.

Wood tables have 1/8" solid wood self edge. P-Lam tables have 1/8" translucent edge. Specify edge type; add the two letter code after the model number.



Self Edge "SE"



Taper Edge "TE" on user side only



Facet Edge "FC" on user side only



Flow Form Edge "FF" on user side only 5% upcharge laminate not available

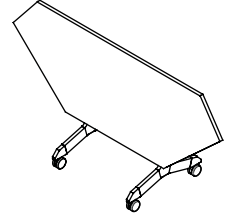
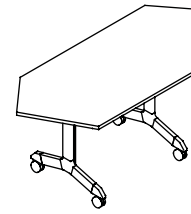

Note: For powder coat base, please use model # of anodized bases and add "PC" at the end, e.g. 30662PC/2.

				1" TOP (SELF EDGE)				1¼" TOP (TAPER, FACET, FLOW FORM EDGES)			
				POLISHED		ANODIZED		POLISHED		ANODIZED	
L" x W" x H"	Top Finish	Model No.	List Price	Model No.	List Price	Model No.	List Price	Model No.	List Price	Model No.	List Price
60 x 24 x 29	Wood	30968/2	3,360	30986/2	3,045	31040/2	3,360	31058/2	3,045		
<b>60 x 24 x 29</b>	<b>P-Lam</b>	<b>30968/5</b>	<b>2,915</b>	<b>30986/5</b>	<b>2,590</b>	<b>31040/5</b>	<b>2,915</b>	<b>31058/5</b>	<b>2,590</b>		
66 x 24 x 29	Wood	30969/2	3,485	30987/2	3,165	31041/2	3,485	31059/2	3,165		
<b>66 x 24 x 29</b>	<b>P-Lam</b>	<b>30969/5</b>	<b>2,980</b>	<b>30987/5</b>	<b>2,665</b>	<b>31041/5</b>	<b>2,980</b>	<b>31059/5</b>	<b>2,665</b>		
72 x 24 x 29	Wood	30970/2	3,595	30988/2	3,275	31042/2	3,595	31060/2	3,275		
<b>72 x 24 x 29</b>	<b>P-Lam</b>	<b>30970/5</b>	<b>3,050</b>	<b>30988/5</b>	<b>2,725</b>	<b>31042/5</b>	<b>3,050</b>	<b>31060/5</b>	<b>2,725</b>		
78 x 24 x 29	Wood	30971/2	3,715	30989/2	3,395	31043/2	3,715	31061/2	3,395		
<b>78 x 24 x 29</b>	<b>P-Lam</b>	<b>30971/5</b>	<b>3,115</b>	<b>30989/5</b>	<b>2,785</b>	<b>31043/5</b>	<b>3,115</b>	<b>31061/5</b>	<b>2,785</b>		
84 x 24 x 29	Wood	30972/2	3,830	30990/2	3,510	31044/2	3,830	31062/2	3,510		
<b>84 x 24 x 29</b>	<b>P-Lam</b>	<b>30972/5</b>	<b>3,170</b>	<b>30990/5</b>	<b>2,850</b>	<b>31044/5</b>	<b>3,170</b>	<b>31062/5</b>	<b>2,850</b>		
90 x 24 x 29	Wood	30973/2	3,945	30991/2	3,625	31045/2	3,945	31063/2	3,625		
<b>90 x 24 x 29</b>	<b>P-Lam</b>	<b>30973/5</b>	<b>3,235</b>	<b>30991/5</b>	<b>2,915</b>	<b>31045/5</b>	<b>3,235</b>	<b>31063/5</b>	<b>2,915</b>		
60 x 30 x 29	Wood	30974/2	3,605	30992/2	3,280	31046/2	3,605	31064/2	3,280		
<b>60 x 30 x 29</b>	<b>P-Lam</b>	<b>30974/5</b>	<b>3,040</b>	<b>30992/5</b>	<b>2,710</b>	<b>31046/5</b>	<b>3,040</b>	<b>31064/5</b>	<b>2,710</b>		
66 x 30 x 29	Wood	30975/2	3,745	30993/2	3,425	31047/2	3,745	31065/2	3,425		
<b>66 x 30 x 29</b>	<b>P-Lam</b>	<b>30975/5</b>	<b>3,115</b>	<b>30993/5</b>	<b>2,785</b>	<b>31047/5</b>	<b>3,115</b>	<b>31065/5</b>	<b>2,785</b>		
72 x 30 x 29	Wood	30976/2	3,885	30994/2	3,565	31048/2	3,885	31066/2	3,565		
<b>72 x 30 x 29</b>	<b>P-Lam</b>	<b>30976/5</b>	<b>3,180</b>	<b>30994/5</b>	<b>2,860</b>	<b>31048/5</b>	<b>3,180</b>	<b>31066/5</b>	<b>2,860</b>		
78 x 30 x 29	Wood	30977/2	4,035	30995/2	3,705	31049/2	4,035	31067/2	3,705		
<b>78 x 30 x 29</b>	<b>P-Lam</b>	<b>30977/5</b>	<b>3,255</b>	<b>30995/5</b>	<b>2,940</b>	<b>31049/5</b>	<b>3,255</b>	<b>31067/5</b>	<b>2,940</b>		
84 x 30 x 29	Wood	30978/2	4,165	30996/2	3,840	31050/2	4,165	31068/2	3,840		
<b>84 x 30 x 29</b>	<b>P-Lam</b>	<b>30978/5</b>	<b>3,335</b>	<b>30996/5</b>	<b>3,020</b>	<b>31050/5</b>	<b>3,335</b>	<b>31068/5</b>	<b>3,020</b>		
90 x 30 x 29	Wood	30979/2	4,305	30997/2	3,980	31051/2	4,305	31069/2	3,980		
<b>90 x 30 x 29</b>	<b>P-Lam</b>	<b>30979/5</b>	<b>3,350</b>	<b>30997/5</b>	<b>3,035</b>	<b>31051/5</b>	<b>3,350</b>	<b>31069/5</b>	<b>3,035</b>		
60 x 36 x 29	Wood	30980/2	3,815	30998/2	3,485	31052/2	3,815	31070/2	3,485		
<b>60 x 36 x 29</b>	<b>P-Lam</b>	<b>30980/5</b>	<b>3,230</b>	<b>30998/5</b>	<b>2,905</b>	<b>31052/5</b>	<b>3,230</b>	<b>31070/5</b>	<b>2,905</b>		
66 x 36 x 29	Wood	30981/2	3,965	30999/2	3,635	31053/2	3,965	31071/2	3,635		
<b>66 x 36 x 29</b>	<b>P-Lam</b>	<b>30981/5</b>	<b>3,295</b>	<b>30999/5</b>	<b>2,970</b>	<b>31053/5</b>	<b>3,295</b>	<b>31071/5</b>	<b>2,970</b>		
72 x 36 x 29	Wood	30982/2	4,165	31000/2	3,840	31054/2	4,165	31072/2	3,840		
<b>72 x 36 x 29</b>	<b>P-Lam</b>	<b>30982/5</b>	<b>3,410</b>	<b>31000/5</b>	<b>3,075</b>	<b>31054/5</b>	<b>3,410</b>	<b>31072/5</b>	<b>3,075</b>		
78 x 36 x 29	Wood	30983/2	4,280	31001/2	3,965	31055/2	4,280	31073/2	3,965		
<b>78 x 36 x 29</b>	<b>P-Lam</b>	<b>30983/5</b>	<b>3,480</b>	<b>31001/5</b>	<b>3,160</b>	<b>31055/5</b>	<b>3,480</b>	<b>31073/5</b>	<b>3,160</b>		
84 x 36 x 29	Wood	30984/2	4,405	31002/2	4,085	31056/2	4,405	31074/2	4,085		
<b>84 x 36 x 29</b>	<b>P-Lam</b>	<b>30984/5</b>	<b>3,530</b>	<b>31002/5</b>	<b>3,210</b>	<b>31056/5</b>	<b>3,530</b>	<b>31074/5</b>	<b>3,210</b>		
90 x 36 x 29	Wood	30985/2	4,610	31003/2	4,280	31057/2	4,610	31075/2	4,280		
<b>90 x 36 x 29</b>	<b>P-Lam</b>	<b>30985/5</b>	<b>3,570</b>	<b>31003/5</b>	<b>3,245</b>	<b>31057/5</b>	<b>3,570</b>	<b>31075/5</b>	<b>3,245</b>		

# METRONOME™ FLIPTOP | WITH MODESTY PANEL

Multi-angle

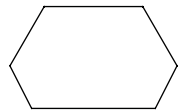

Tables shown this page are standard with Metronome base, locking casters, 5" tall modesty panel in matching finish and 1¼" thick top.

Wood tables have 1/8" solid wood self edge. P-Lam tables have 1/8" translucent edge.  
Specify edge type; add the two letter code after the model number.



Self Edge "SE"



Taper Edge "TE"  
on user side only



Facet Edge "FC"  
on user side only



Flow Form Edge "FF" on user side  
only 5% upcharge  
laminates not available

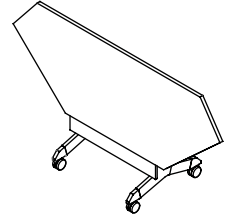
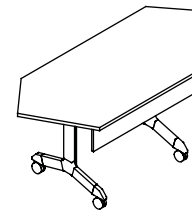

Note: For powder coat base, please use model # of anodized bases and add "PC" at the end, e.g. 30662PC/2.

## 1" TOP (SELF EDGE)

## 1¼" TOP (TAPER, FACET, FLOW FORM EDGES)

L" x W" x H"	Top Finish	POLISHED		ANODIZED		POLISHED		ANODIZED	
		Model No.	List Price	Model No.	List Price	Model No.	List Price	Model No.	List Price
60 x 24 x 29	Wood	30932/2	3,935	30950/2	3,615	31004/2	3,935	31022/2	3,615
<b>60 x 24 x 29</b>	<b>P-Lam</b>	<b>30932/5</b>	<b>3,340</b>	<b>30950/5</b>	<b>3,025</b>	<b>31004/5</b>	<b>3,340</b>	<b>31022/5</b>	<b>3,025</b>
66 x 24 x 29	Wood	30933/2	4,100	30951/2	3,785	31005/2	4,100	31023/2	3,785
<b>66 x 24 x 29</b>	<b>P-Lam</b>	<b>30933/5</b>	<b>3,460</b>	<b>30951/5</b>	<b>3,145</b>	<b>31005/5</b>	<b>3,460</b>	<b>31023/5</b>	<b>3,145</b>
72 x 24 x 29	Wood	30934/2	4,275	30952/2	3,960	31006/2	4,275	31024/2	3,960
<b>72 x 24 x 29</b>	<b>P-Lam</b>	<b>30934/5</b>	<b>3,565</b>	<b>30952/5</b>	<b>3,240</b>	<b>31006/5</b>	<b>3,565</b>	<b>31024/5</b>	<b>3,240</b>
78 x 24 x 29	Wood	30935/2	4,480	30953/2	4,155	31007/2	4,480	31025/2	4,155
<b>78 x 24 x 29</b>	<b>P-Lam</b>	<b>30935/5</b>	<b>3,700</b>	<b>30953/5</b>	<b>3,375</b>	<b>31007/5</b>	<b>3,700</b>	<b>31025/5</b>	<b>3,375</b>
84 x 24 x 29	Wood	30936/2	4,660	30954/2	4,340	31008/2	4,660	31026/2	4,340
<b>84 x 24 x 29</b>	<b>P-Lam</b>	<b>30936/5</b>	<b>3,825</b>	<b>30954/5</b>	<b>3,500</b>	<b>31008/5</b>	<b>3,825</b>	<b>31026/5</b>	<b>3,500</b>
90 x 24 x 29	Wood	30937/2	4,855	30955/2	4,525	31009/2	4,855	31027/2	4,525
<b>90 x 24 x 29</b>	<b>P-Lam</b>	<b>30937/5</b>	<b>3,940</b>	<b>30955/5</b>	<b>3,620</b>	<b>31009/5</b>	<b>3,940</b>	<b>31027/5</b>	<b>3,620</b>
60 x 30 x 29	Wood	30938/2	4,175	30956/2	3,850	31010/2	4,175	31028/2	3,850
<b>60 x 30 x 29</b>	<b>P-Lam</b>	<b>30938/5</b>	<b>3,450</b>	<b>30956/5</b>	<b>3,135</b>	<b>31010/5</b>	<b>3,450</b>	<b>31028/5</b>	<b>3,135</b>
66 x 30 x 29	Wood	30939/2	4,360	30957/2	4,040	31011/2	4,360	31029/2	4,040
<b>66 x 30 x 29</b>	<b>P-Lam</b>	<b>30939/5</b>	<b>3,585</b>	<b>30957/5</b>	<b>3,260</b>	<b>31011/5</b>	<b>3,585</b>	<b>31029/5</b>	<b>3,260</b>
72 x 30 x 29	Wood	30940/2	4,555	30958/2	4,230	31012/2	4,555	31030/2	4,230
<b>72 x 30 x 29</b>	<b>P-Lam</b>	<b>30940/5</b>	<b>3,700</b>	<b>30958/5</b>	<b>3,375</b>	<b>31012/5</b>	<b>3,700</b>	<b>31030/5</b>	<b>3,375</b>
78 x 30 x 29	Wood	30941/2	4,785	30959/2	4,470	31013/2	4,785	31031/2	4,470
<b>78 x 30 x 29</b>	<b>P-Lam</b>	<b>30941/5</b>	<b>3,850</b>	<b>30959/5</b>	<b>3,530</b>	<b>31013/5</b>	<b>3,850</b>	<b>31031/5</b>	<b>3,530</b>
84 x 30 x 29	Wood	30942/2	5,005	30960/2	4,680	31014/2	5,005	31032/2	4,680
<b>84 x 30 x 29</b>	<b>P-Lam</b>	<b>30942/5</b>	<b>3,980</b>	<b>30960/5</b>	<b>3,660</b>	<b>31014/5</b>	<b>3,980</b>	<b>31032/5</b>	<b>3,660</b>
90 x 30 x 29	Wood	30943/2	5,220	30961/2	4,895	31015/2	5,220	31033/2	4,895
<b>90 x 30 x 29</b>	<b>P-Lam</b>	<b>30943/5</b>	<b>4,055</b>	<b>30961/5</b>	<b>3,735</b>	<b>31015/5</b>	<b>4,055</b>	<b>31033/5</b>	<b>3,735</b>
60 x 36 x 29	Wood	30944/2	4,430	30962/2	4,100	31016/2	4,430	31034/2	4,100
<b>60 x 36 x 29</b>	<b>P-Lam</b>	<b>30944/5</b>	<b>3,675</b>	<b>30962/5</b>	<b>3,350</b>	<b>31016/5</b>	<b>3,675</b>	<b>31034/5</b>	<b>3,350</b>
66 x 36 x 29	Wood	30945/2	4,645	30963/2	4,320	31017/2	4,645	31035/2	4,320
<b>66 x 36 x 29</b>	<b>P-Lam</b>	<b>30945/5</b>	<b>3,805</b>	<b>30963/5</b>	<b>3,475</b>	<b>31017/5</b>	<b>3,805</b>	<b>31035/5</b>	<b>3,475</b>
72 x 36 x 29	Wood	30946/2	4,875	30964/2	4,555	31018/2	4,875	31036/2	4,555
<b>72 x 36 x 29</b>	<b>P-Lam</b>	<b>30946/5</b>	<b>3,990</b>	<b>30964/5</b>	<b>3,670</b>	<b>31018/5</b>	<b>3,990</b>	<b>31036/5</b>	<b>3,670</b>
78 x 36 x 29	Wood	30947/2	5,220	30965/2	4,895	31019/2	5,220	31037/2	4,895
<b>78 x 36 x 29</b>	<b>P-Lam</b>	<b>30947/5</b>	<b>4,055</b>	<b>30965/5</b>	<b>3,735</b>	<b>31019/5</b>	<b>4,055</b>	<b>31037/5</b>	<b>3,735</b>
84 x 36 x 29	Wood	30948/2	5,360	30966/2	5,030	31020/2	5,360	31038/2	5,030
<b>84 x 36 x 29</b>	<b>P-Lam</b>	<b>30948/5</b>	<b>4,180</b>	<b>30966/5</b>	<b>3,855</b>	<b>31020/5</b>	<b>4,180</b>	<b>31038/5</b>	<b>3,855</b>
90 x 36 x 29	Wood	30949/2	5,580	30967/2	5,255	31021/2	5,580	31039/2	5,255
<b>90 x 36 x 29</b>	<b>P-Lam</b>	<b>30949/5</b>	<b>4,300</b>	<b>30967/5</b>	<b>3,975</b>	<b>31021/5</b>	<b>4,300</b>	<b>31039/5</b>	<b>3,975</b>

# METRONOME™ FLIPTOP | WITH NO MODESTY PANEL

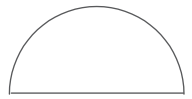

Tables shown this page are standard with Metronome base, locking casters. Top is 1" thick for self edge and 1¼" thick for profile edges.

Wood tables have 1/8" solid wood self edge. P-Lam tables have 1/8" translucent edge. Specify edge type; add the two letter code after the model number.

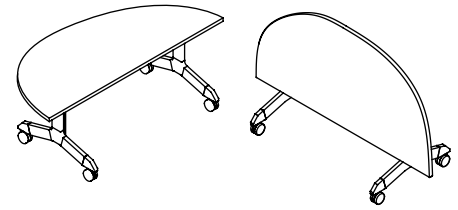

Self Edge "SE"



Taper Edge "TE"  
on user side only



Facet Edge "FC"  
on user side only



Flow Form Edge "FF" on user  
side only 5% upcharge  
laminates not available

Note: For powder coat base, please use model # of anodized bases and add "PC" at the end, e.g. 30662PC/2.

## 1" TOP (SELF EDGE)

## 1¼" TOP (TAPER, FACET, FLOW FORM EDGE)

L" x W" x H"	Top Finish	POLISHED		ANODIZED		POLISHED		ANODIZED	
		Model No.	List Price	Model No.	List Price	Model No.	List Price	Model No.	List Price
48 x 24 x 29	Wood	31076/2	2,655	31079/2	2,330	31082/2	2,655	31085/2	2,330
<b>48 x 24 x 29</b>	<b>P-Lam</b>	<b>31076/5</b>	<b>2,315</b>	<b>31079/5</b>	<b>1,990</b>	<b>31082/5</b>	<b>2,315</b>	<b>31085/5</b>	<b>1,990</b>
60 x 30 x 29	Wood	31077/2	3,175	31080/2	2,855	31083/2	3,175	31086/2	2,855
<b>60 x 30 x 29</b>	<b>P-Lam</b>	<b>31077/5</b>	<b>2,680</b>	<b>31080/5</b>	<b>2,360</b>	<b>31083/5</b>	<b>2,680</b>	<b>31086/5</b>	<b>2,360</b>
60 x 36 x 29	Wood	31078/2	3,355	31081/2	3,040	31084/2	3,355	31087/2	3,040
<b>60 x 36 x 29</b>	<b>P-Lam</b>	<b>31078/5</b>	<b>2,850</b>	<b>31081/5</b>	<b>2,530</b>	<b>31084/5</b>	<b>2,850</b>	<b>31087/5</b>	<b>2,530</b>

