

Vox[®] Reception Desk

Mark Muller



nienkämper

Prices include freight charges, blanket wrapped, dock delivered, from the manufacturing source to any location in the contiguous United States. Packing and/or crating are available, if required, upcharges apply.

FORWARD

Vox® Circulation - Reception Desks



Library Circulation and Corporate Reception environments demand flexible design solutions that can provide multi-function, task driven and beautiful furniture. The Vox Circulation/Reception™ Desk addresses these needs with a kit of parts design philosophy that offers the designer a wealth of components and features to resolve any of these requirements.

Components in a range of sizes can be joined together in unlimited configurations for unique appearances with clean edges and contrasting surfaces. Carefully engineered height adjustable work surfaces and mobile storage elements add to the design possibilities.

It is the most comprehensive product on the market with unprecedented functionality; a range of esthetic possibilities and the ability to be constructed on any scale.

The Vox Circulation/Reception Desk ensures that the work environment is as productive as it is beautiful.

TABLE OF CONTENTS

Forword	3
Tables of Contents	4
Features Overview - (Illustration)	7-8
Wood Veneer / Finishes	9
Wood Grain Plastic Laminate / Edges Options	10
Coloured Laminates / Metal Finishes / Paint Finishes	11
Desk Top Screens	12
Glass Surfaces	13
Grommets	14
Book Drop Features / Cart	15
Vox Power Channel	16-17
Vox Wire Managers	18
Vox High Performance Surge Protector	19
Height Adjustable Options	20
File Storage Capacity	21
Moveable Storage Elements	22-23
Drawer / Door Pull Options	24
Accessories for Accessory Rail	25-28
Task Lighting	29-30
Monitor Supports	31-32
CPU Holders	33-34
Keyboard Supports	35-36
Pencil Trays / Storage	37
Desk Examples	38-47
CAD Drawings	48
End Panels	49-50
Terms and Conditions of Sale	51

VOX® CIRCULATION-RECEPTION DESK – FEATURES

DESIGN - MARK MULLER

The Vox Circulation desk design is based on a series of carefully engineered components that are both versatile and comprehensive. They can be incorporated into a variety of configurations that are suitable for Library Circulation, Reference and Information style desks constructed to any scale.

Refer to pages 7 and 8 for illustrated number references **(1)** to **(14)**.

Support Structure

The design begins with two rectangular aluminum extrusions that are joined together along with two 3/8" thick panels to make up the base assembly **(1)**. Easily accessible levelers within the base assembly include 2 1/2" of adjustment.

When the bases are attached at right angles to vertical/modesty panels (3/4" thick) they provide the main under-structure of the desk

Components are held together with a simple but ingenious connector system that allows for quick and easy assembly of all of the components on site **(2)**.

Vertical/modesty panels **(3)** are available in the full range of Nienkamper surfaces and finishes found on pages 10-12

Tops

Top surfaces are 1 1/4" thick with a standard depth of 32". Top surfaces are standard with a 2" wide "Tapered Edge" or profiled "Facet Edge" or "Self Edged" **(4)**.

Raised gallery tops are also 1 1/4" thick with a standard depth of 16" **(5)**. Gallery tops are supported by an extruded aluminum profile that also includes an integrated gallery screen **(6)**.

Primary tops, Gallery tops and Screens can be made of any of the standard Nienkamper surfaces and finishes found on pages 10-12

Optional cultured quartz stone (Caesar Stone) is also available for top surfaces. Other stones and some special materials may be utilized – Contact Nienkamper customer service at 1 800 668 9318 for suitability.

Screens

In addition to gallery screens that are incorporated into gallery top supports (6), independent and freestanding privacy screens are also available **(7)**. These surface mounted screens are supported with slim extruded brackets that clamp the screen panel to the work surface **(8)**. This method of attachment allows the screens to be positioned virtually anywhere on a top surface. Both screen types are available in the full range of Nienkamper surfaces and finishes found on pages 10-12. Screens are also available in a number of glass options that can be found on page 14.

Height adjustable elements

Desk sections are also available with a height adjustable feature **(9)**. This option integrates a pair of gear driven height adjusting legs into the base assemblies that operates by an electrical motor and control system **(10)**. The simple up/down control unit is positioned under the front edge of the top for adjustment of the work-surface. The sit/stand height range is from 29" to 49" tall. Top sizes are limited to a maximum of 66" wide by 32" deep, see page 21.

VOX® CIRCULATION-RECEPTION DESK – FEATURES

DESIGN - MARK MULLER

Storage Elements

A range of portable storage pedestals **(11)** are available that include both storage and file interiors, listed on page 23-24. page 22 describes file storage capacity and page 25 pull styles available. All storage pedestals are available in the full range of Nienkamper surfaces and finishes found on pages 10-12.

Grommets

Three different options are available for access through the desk top (13). See page 15 for specific details.

i A plastic grommet rectangular in shape - 2" x 4" Available in three colours.

ii An aluminum grommet rectangular in shape, installed flush to the top – 2 1/4" x 5" Finished in anodized aluminum.

iii A large aluminum cable access port allowing connections to be made from the top of the desk – 6" x 8".

Power/Voice-Data

The Vox® Power Channel™ is a power, data-voice distribution system (12) that provides connections for all library related connectivity that is easily accessed in a divided aluminum channel 5 1/4" H x 2 1/4" D.

The Vox® Power Channel™ arrives completely wired with a range of electrical options that include multiple electric outlets. Standard 3 or optional 4 circuit systems with corresponding numbered receptacles that allow ease of circuit selection or reconfiguring after installation.

All major data manufacturers' jacks are fully integrated into plastic bezel mounted faceplates. Three positions are standard in each bezel with Amp Cat 6 data, Amp Cat 5E voice and one single blank position for expansion.

All Vox® Power Channel™ users can easily connect to the system through optional grommets or the desk top access port that is repositioned flush to the worktop concealing all connections.

See pages 17-18 for Vox Power Channel features and options.

Wire Management

Three wire management features are available with the desk. A 12"L x 4" W x 1" H section of black plastic multi-channel extrusion is provided with all desk elements.

This extrusion is self adhesive and intended to be positioned as the user needs under the work-surfaces (page 19). Additionally a grey plastic "J"-channel extrusion 4" W x 4" D is provided for mounting onto the interior of all modesty panels (14). This channel is precut to fit between the vertical legs of the desk and positioned just below the work-surface. A floor mounted cable manager "Power Bridge" is intended to protect and cover cables that may need to be placed in high traffic areas (5/8" x 6 1/8"). Wire managers can be found on page 19.

Book Drop

A book drop feature can be added to any work-surface. The 3 1/2" W x 12"L slot is framed on the two long sides with an aluminum strip to prevent excessive wear along the edges of the hole. A book drop cart is also available in a scale that can be accommodated below the work-surface. See page 16 for book drop details

VOX® CIRCULATION-RECEPTION DESK - FEATURES

DESIGN - MARK MULLER

Refer to pages 6-7 for numbered descriptions

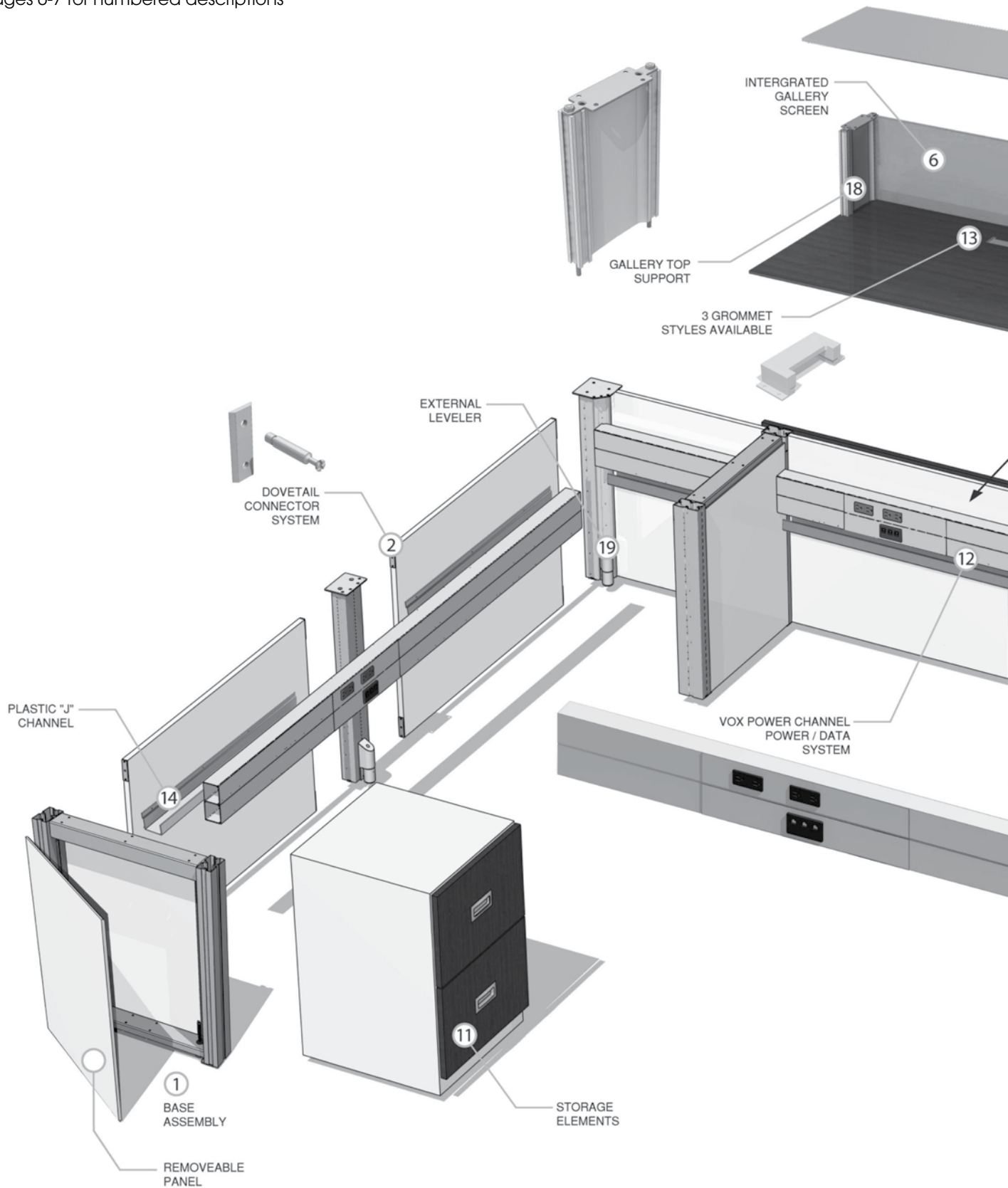

VOX® CIRCULATION-RECEPTION DESK – FEATURES

DESIGN - MARK MULLER

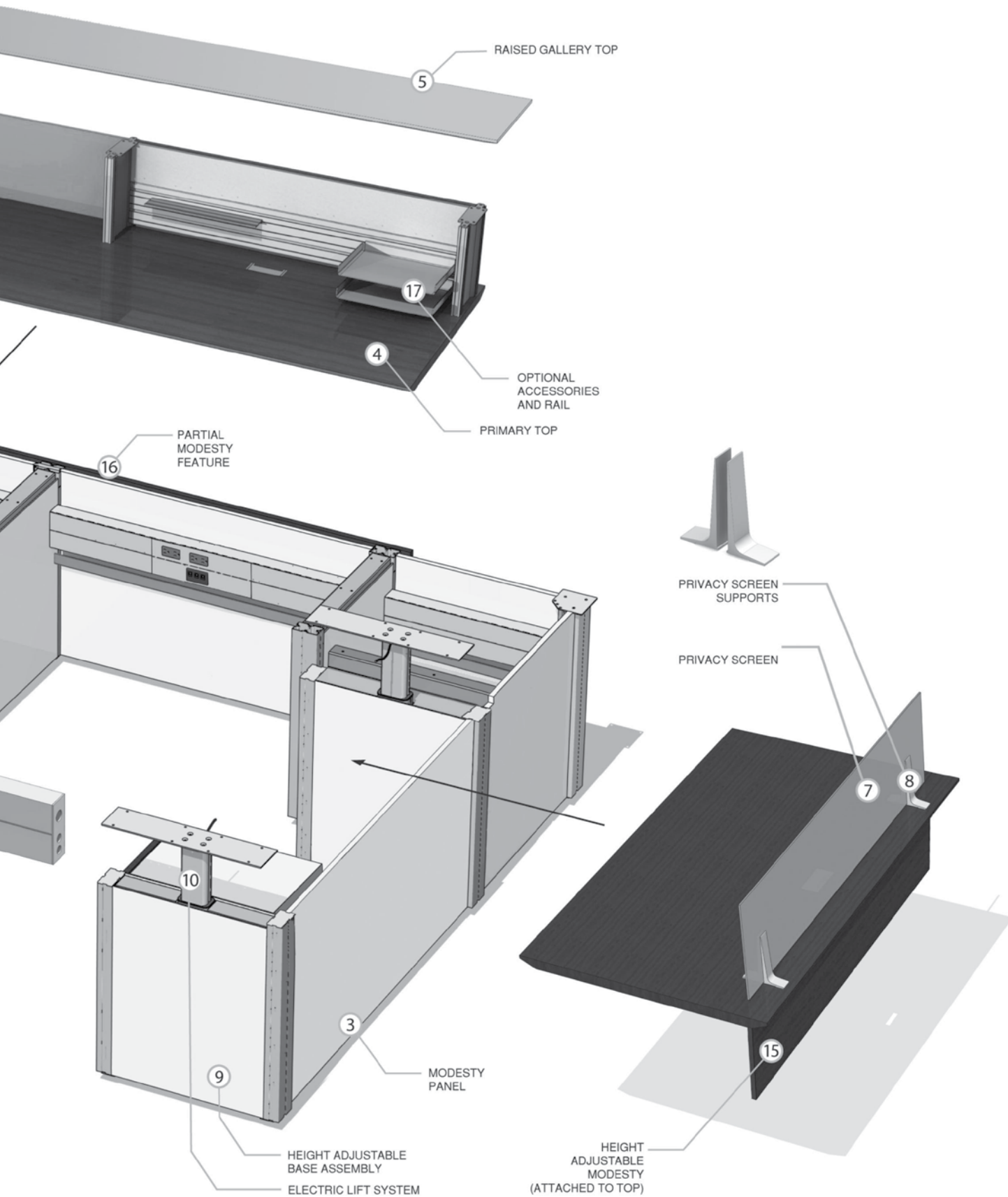

veneers

All wood surfaces are protected with a durable polyurethane clear laquer with UV inhibitor. This finish is known for its exceptional durability, as well as abrasion, chemical, impact and scratch resistance. Standard sheen level is 45 degrees. Optional 10 and 35 degree sheen levels are available on request at no additional cost.

Wood Species	Order Code	Veneer/Stain	Upcharge
Maple	F-01	Natural Maple	No upcharge applies.
	F-02	Natural Curly Maple - Rotary Cut	Add 15%.
	F-03	Natural Bird's Eye Maple - Rotary Cut	Call Customer Service for pricing.
	F-04	Maple Stained Pear	No upcharge applies.
Cherry	F-05	Natural Cherry	No upcharge applies.
	F-06	Standard Cherry	No upcharge applies.
	F-07	Cherry Stained Amber	No upcharge applies.
	F-08	Cherry Stained Auburn	No upcharge applies.
	F-09	Cherry Stained Burgundy	No upcharge applies.
Mahogany	F-10	Light Mahogany	No upcharge applies.
	F-11	Medium Mahogany	No upcharge applies.
	F-12	Dark Mahogany	No upcharge applies.
	F-13	Red Mahogany	No upcharge applies.
Anagre	F-14	Natural Figured Anagre - Qtr. Cut Book-Match	Add 15%.
	F-15	Figured Anagre Stained Amber - Qtr. Cut Book-Match	Add 15%.
Sycamore	F-16	Natural Figured Sycamore - Qtr. Cut Book-Match	Add 15%.
Walnut	F-17	Burnt Walnut	No upcharge applies.
	F-19	Natural Walnut	No upcharge applies.
	F-24	Carbon Grey Walnut	No upcharge applies.
White Oak	F-18	Natural White Oak - Flat Cut Book-Match (10° sheen)	No upcharge applies.
		Natural White Oak - Rift Cut Slip-Match (10° sheen)	Add 5%
Sapele – Ribbon Stripe	F-20	Natural Ribbon Strip Sepele - Qtr. Cut Slip-Match	No upcharge applies.
Moabe (Cherry substitute)	F-21	Natural Moabe - Quarter - Qtr. Cut Book-Match	No upcharge applies.
Cape Coast Walnut	F-22	Dark Cape Coast Walnut - Qtr. Cut Slip-Match	No upcharge applies.
	F-23	Natural Cape Coast Walnut - Qtr. Cut Slip-Match	No upcharge applies.
Ash	F-25	Slate Grey Ash - Qtr. Cut Slip-Match	No upcharge applies.

VENEER GRAIN OPTIONS

Nienkamper products utilize the best quality veneers available, and, combined with Nienkämper's patented veneering systems, create work environments of incredible quality and beauty.

All veneer furniture comes standard with flat cut book-match veneer; flat cut slip-match veneer can also be specified. Quarter cut slip-match and quarter cut book-match veneers are available at a 5% upcharge. Figured Anagre and Figured Sycamore veneers are Quarter cut book-matched. Bird's Eye Maple and Curly Maple are rotary cut.

Facet Edge, Taper edge and Flowform edge tops with veneer are manufactured with a solid wood edge. All edges are then veneer wrapped to create a seamless profile top.

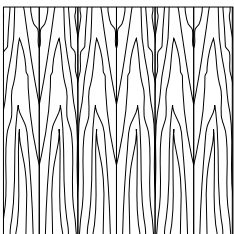

Standard Flat Cut Book-Match V1

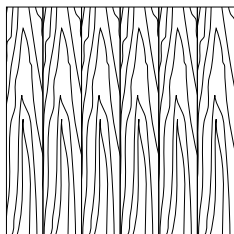

Flat Cut Slip-Match V2

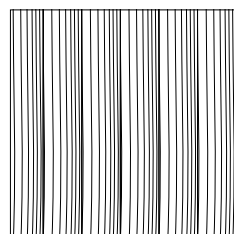

Quarter Cut Slip-Match V3
Add 5%

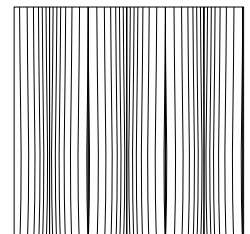

Quarter Cut Book-Match V4
Add 5%

P-LAM

Wood grain plastic laminate surfaces are available on table tops with Facet and Taper edges.

These tops are manufactured with a solid wood edge that is applied prior to the laminate top surface. This method conceals the thickness of the wood edge, while providing the durability required. Wood edges are selected that most closely resemble both the species and the color of the laminate chosen

Nienkämper has pre-selected a number of standard wood grain plastic laminates that represent a cross section of both color and species. Simply include the order code with the model number to make these selections. Alternatively wood grain plastic laminates selected outside of Nienkämper's standard selection can be made by specifying the manufacturer as well as the description and model number of the laminate at the time of order. Note: for Facet edge tops the laminate must be a post-forming grade.

Wood Grain Plastic Laminate Surfaces	Order Code	Manufacturer #	Finish
Champagne Sagawood	WL1	Nevamar WM8349T	Textured
Hardrock Maple	WL2	Pionite WM791-SD	Textured/Suede
Amber Curly Maple	WL3	Pionite WM221-SD	Textured/Suede
Anagre	WL4	Pionite WX041-SD	Textured/Suede
Monticello Maple	WL5	Wilsonart 7925-38	Fine Velvet Texture
Millwork Cherry	WL7	Pionite WC431PV	PV-Polished Velvet
Figured Anagre	WL8	Formica7284-58	Matte
Huntington Maple	WL9	Wilsonart 7929-38	Fine Velvet Texture
Wild Cherry	WL10	Formica 5904.43	Artisan
Amber Cherry	WL11	Wilsonart 7919.38	Fine Velvet Texture
Figured Mahogany	WL12	Wilsonart 7040A-60	Matte
Fusion Maple	WL13	Wilsonart 7909-78	Fine Grain
New Age Oak	WL14	Wilsonart 7938-78	Fine Grain
Natural Pear	WL15	Wilsonart 7061-78	Fine Grain
Tuscan Walnut	WL16	Wilsonart 7921-78	Fine Grain
Nepal Teak	WL17	Wilsonart 7209-78	Fine Grain
Wild Cherry	WL18	Wilsonart 7054-78	Fine Grani
River Cherry	WL19	Wilsonart 7937-78	Fine Grain
Montana Walnut	WL20	Wilsonart 7110-78	Fine Grain
Sanara	WL21	Wilsonart 7932-78	Fine Grain
Windsor Mahogany	WL22	Wilsonart 7039-78	Fine Grain
Williamsburg Cherry	WL23	Wilsonart 7936-78	Fine Grain
Florence Walnut	WL25	Wilsonart 7993-78	Fine Grain
Skyline Walnut	WL26	Wilsonart 7964K-12	Soft Grain
Sterling Ash	WL27	Wilsonart 7995-78	Fine Grain

To specify the wood grain laminate required simply add the Order Code WL_ to the model number of the product.

Wood grain laminate samples are available from your local sales representative or by calling Nienkämper's customer service department at 1-800-668-9318.

Standard Edge Profiles Available

Note: Facet edge tops are available in veneer or laminate only.

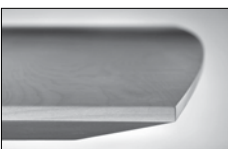

Taper Edge "TE"

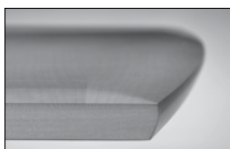

Facet Edge "FE"

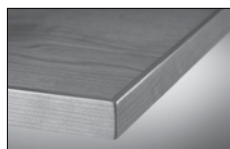

Self Edge "SE"

P-LAM

COLOURED P-LAM

Both Taper and Facet edge profiles are available with a colored laminate top.

Laminate edging on Taper tops. Edging will match the top surface and is applied prior to the surface laminate. By applying the laminate in this way the seam is positioned horizontally, is much less conspicuous as well as more durable.

Wood edging on Facet and Taper Edge tops is applied prior to the laminate. By applying the wood edge in this way the thickness of the wood edge is concealed, while providing the durability required. Wood species and finishes for edging, can be selected from page 4.

For laminates specified outside of Nienkämper's standard selection, specify the manufacturer as well as the description and model number of the laminate selected at time of order. For Facet edge tops, the laminate must be a post forming grade.

Translucent edging on Taper edge tops is applied after the surface laminate. The translucent edge is very durable. Clear translucent edge provides a good match with most white colored laminates, while silver translucent edge provides a metallic look and contrast to colored plastic laminates.



Taper edge in clear translucent with white P-Lam top

Coloured Plastic Laminates Surface	Order Code	Manufacturer #	Finish
Grey (Nienkamper - Light Grey/Putty)	CL-01	Wilsonart 1500-60	Matte
Plantinum Gray (Nienkamper - Medium Grey/Clay)	CL-02	Nevamar S6023T	Textured
Slate Grey (Nienkamper - Dark Grey)	CL-03	Wilsonart D91-60	Matte
Black	CL-04	Wilsonart 1595-60	Matte
Angel White	CL-05	Pionite SW-826SD	Textured/Suede
Frosty White	CL-06	Wilsonart 1573-60	Matte
White (for writable surface)	CL-07	Formica 949-90	Gloss

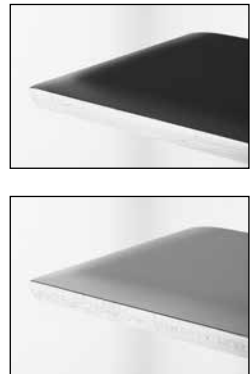

Add the order code behind the edge profile when specifying.

VOX® CIRCULATION-RECEPTION DESK – SCREENS

Desk screens are available in two distinct design configurations for any Vox Circulation Desk.

1. Gallery screens that are located below gallery tops and include aluminum gallery top supports
2. Independent privacy screens with no top that include aluminum mounting clips

Gallery Screens

Available in all of the standard Nienkämper laminates, veneers and glass surfaces gallery screens offer a wide range of aesthetic and practical options. The screens are inserted into the grooves that are located on the sides of the aluminum gallery supports.

Raised gallery tops are 1 1/4" thick with a standard depth of 16". Gallery tops are supported by an extruded aluminum profile that includes an integrated gallery screen.



Laminate (page 11)



Veneer (page 10)



Glass (page 14)

Privacy Screens

Privacy screens are independent and freestanding screens that are surface mounted and supported with slim extruded brackets that clamp the screen panel to the work surface. Available in all of the standard Nienkämper laminates, veneers and glass surfaces these privacy screens offer a wide range of aesthetic and practical options.

This method of attachment allows these screens to be positioned virtually anywhere along a top surface.



Laminate (page 11)

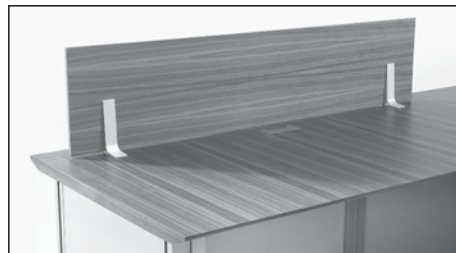

Veneer (page 10)



Glass (page 14)

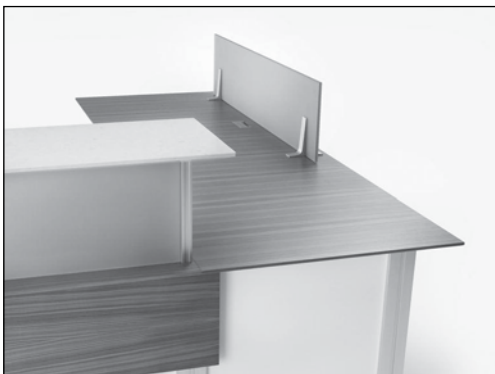

Gallery screen in foreground
Privacy screen in background

VOX® CIRCULATION-RECEPTION DESK – GLASS SURFACES

Optional glass surfaces can be specified for both Gallery Screens and Privacy Screens on page 13. The following detailed descriptions are provided for specifying these optional glass surfaces. Finished and exposed edges of glass are referred to as "Flat Polished Edge". Flat polished edges include a small chamfer on both edges of the sheet.

RG – Regular Glass or Float Glass is the standard glass used in most applications. Float glass is available in a wide range of thicknesses for a variety of applications. Its slight green colour is amplified as the thicknesses increase.

LIG – Low Iron Glass is sometimes referred to as crystal glass, star-fire glass or clear glass. It is unique because of the absence of any green colour like that found in regular float glass. It is a true clear glass that is the result of the elimination of iron during the manufacturing process.

T – Tempered Glass is required for most furniture applications. Four to five times stronger than regular glass, tempered glass is made by heating and cooling thereby preventing it from breaking into sharp shards when it fails. All Nienkämper glass is either tempered or laminated for safety.

E – Etched Glass refers to a chemical etching process that provides a smooth but dulled surface finish that is translucent in appearance. One and or two sides of glass sheets may be etched depending on the application.

LG – Laminated Glass is a process where thin layers of clear polyvinyl film are laminated between two sheets of glass. Like tempered glass laminated glass is a type of safety glass that keeps the layers of glass bonded even when broken.

CLG – Coloured Laminated Glass is identical to the process used when making regular laminated glass with some additional processes. Polyvinyl films are included in the interlayer that can produce a variety of effects like translucency,

VOX® CIRCULATION-RECEPTION DESK – GROMMETS

Standard Grommet

This large rectangular plastic grommet has capacity for the most demanding wire management needs. When not in use the hinged cover swings up to close the grommet. Overall dimension is 4" L x 2" W (Interior clearance – 35/8" L x 15/8" W).

Available in three colours to coordinate with a variety of top finishes

Model #	Colour	List \$
70286	Black	55
70287	Cool Grey	55
70288	Warm Grey	55

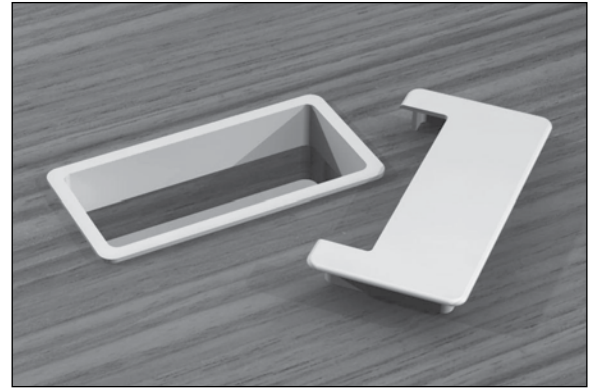

Aluminum Grommet

A high quality grommet option that can be finished in the same anodized aluminum colours as the rest of the desk. These grommets offer a nice contrast to any top surface and are built to withstand many years of use. Made of a heavy gauge aluminum extrusion with a large access hole. Covers will not pull out during use. Overall dimension is 5 1/4" L x 2 1/4" W (Interior clearance – 4 3/4" L X 2 1/4" W).

Model #	Colour	List \$
70277	Anodized	280

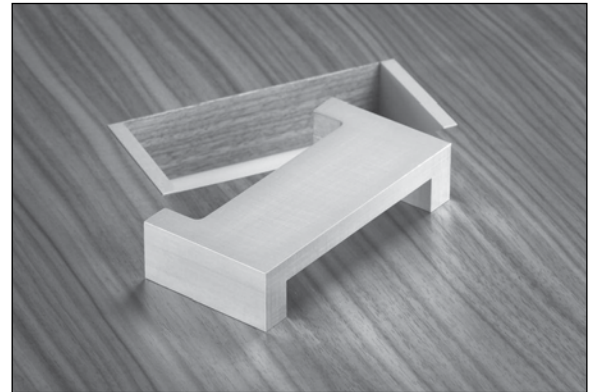

Aluminum Power Channel Access Port

A large desk top access port that can be finished in anodized colours to match the rest of the desk. Specified when regular access is required in a desktop to power/data/voice elements below. This simple component allows users to easily remove the cover and immediately identify the connections required from a position above the work-surface (when being used with Vox Power Channel). A large slot along the back edge of the port allows quantities of cables to be accommodated. There is sufficient room for the user to place a hand through the opening and connect or disconnect the required cables. Ideal for laptop computer use and made of heavy gauge aluminum, covers will not pull out during use. Overall dimension is 8" L x 5" W (Interior clearance – 4 3/4" L X 2 1/4" W).

Model #	Colour	List \$
70830	Anodized	545

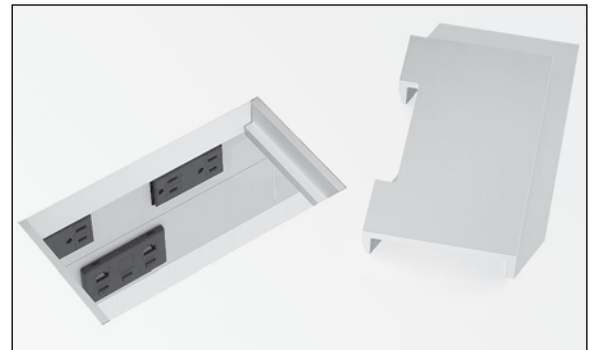

VOX® CIRCULATION-RECEPTION DESK – BOOK DROP/BOOK CART

DESIGN – MARK MÜLLER

Vox Book Drop Slot

Any Vox desk can include a book drop slot that is incorporated in the top surface of the desk. The slot is 31/2" W x 12" L and framed on two sides with an aluminium strip. The purpose of the strip is to prevent excessive wear along the edges of the hole.

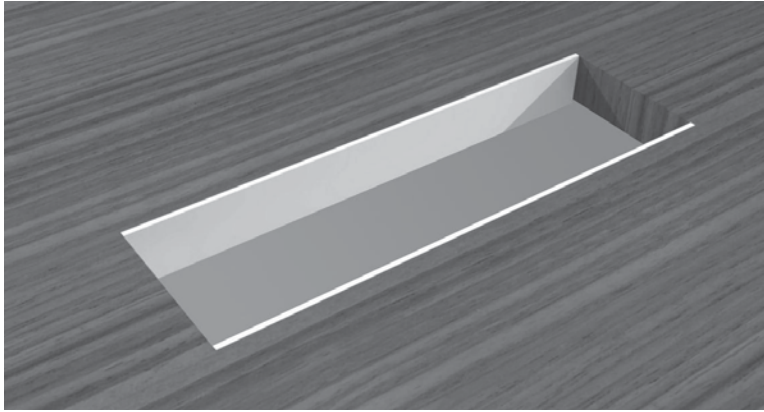

Model #

70280

List \$

245

Vox Book Drop Cart

A book drop cart is also available 30" L x 18" W x 26" H. The cart can be finished in any of the standard Nienkamper finishes found on pages 10-12. Included with the cart are four commercial grade, non marking, lockable casters. A folding and flush mounted plastic handle is built into one side of the cart allowing for ease of movement. Book carts can be manufactured in a variety of sizes that can accommodate any scale of Vox Desk.



Model #

70285/5

70285/2

Finish

Laminate

Veneer

List \$

2,415

2,760

VOX® – POWER CHANNEL™

DESIGN – MARK MÜLLER



Product description

Vox® Power Channel™ is a power distribution system introduced for Vox® Circulation-Reception Desks™. Connections for power, data, voice or any other related connectivity are easily accessed in a single divided channel that accommodates all necessary connections.

The Vox® Power Channel™ arrives completely cabled with a range of standard factory installed electrical options that include single or multiple electric outlets. A standard 3 or optional 4 circuit power system, which includes corresponding numbered receptacles that allow ease of circuit selection and reconfiguring after installation.

Amp Cat 6 jacks are standard for data connections with direct wiring/punch-down installed in the field. Bezel mounted faceplates allow alternative data manufacturers' jacks to be fully integrated into the co-extruded channel profile.

Vox® Power Channel™ users can easily connect to the system through the optional desk top Grommets or Access Port that is repositioned flush to the worktop concealing all connections.



Standard Vox Power Channel configuration 2-duplex receptacles, 1 Data, 1 Blank, 1 Voice



Vox Power Channel installed in the desk

VOX® – POWER CHANNEL™

DESIGN – MARK MÜLLER

Vox® PowerChannel™

Vox® PowerChannel™ is a new power distribution system introduced for Vox® OpenOffice™. Vox® PowerChannel™ provides OpenOffice™ tables or desks with connections for power, data, voice or any other workstation related connectivity that can be easily accessed in a single divided channel.

Vox® PowerChannel™ arrives completely wired with a range of standard clustered connections that can be easily specified. A standard 3 or optional 4 circuit system, along with corresponding numbered receptacles allow ease of circuit selection or reconfiguring after installation.

All major data manufacturers' jacks are fully integrated into the co-extruded channel profile. Alternative connections can be easily accepted with plastic bezel mounted faceplates. (Refer to page 13 for PowerChannel™ specifications and options)



A – 1-Duplex, No Data/Voice jacks, No blank positions available.



B – 1-Duplex, 2 Data/Voice jacks (2 amp cat 5E RJ 45),
1 Blank position available

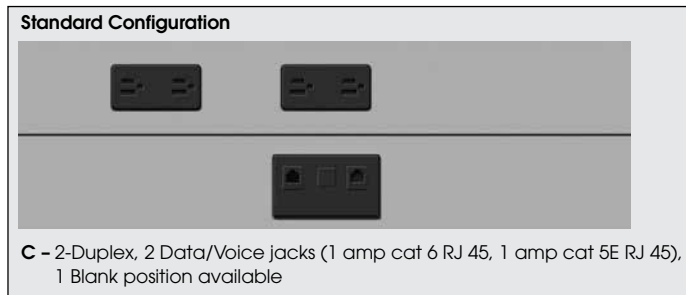

D – 3-Duplex, 2 Data/Voice jacks (2 amp cat 5E RJ 45),
1 Blank position available

Power and Circuit Selections

Power and circuit elements are based on a modular wiring system. Two options are available for power; a standard 5 wire/3 circuit or alternatively an 8 wire/4 circuit.

Each receptacle can be provided with its own circuit selection. Circuits are identified on the product with a small numerical indicator in the upper right hand corner of each receptacle. This system is flexible as receptacles may be changed on site to utilize alternative circuits.



To specify Vox® PowerChannel™ components and circuits, contact Nienkämper customer service at 1-800-668-9318 for assistance.

	Model Number	Length	List Price	Product Description
POWER BRIDGE	55028-48	48"	450	This floor mounted cable manager "Power Bridge" is intended to protect and cover cables which may be placed over traffic areas. Made of aluminum and anodized clear it has a removable strip that allows for concealing attachment screws. It can also be mounted with 2 sided tape. This cable manager has two separate cavities that accommodate 10 data style cables or three 16 gauge power cables in each cavity.
	55028-96	96"	710	

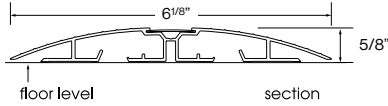

NOTE: Custom lengths can be ordered. Contact Customer Service at **1.800.668.9318** for pricing.



Model #55028

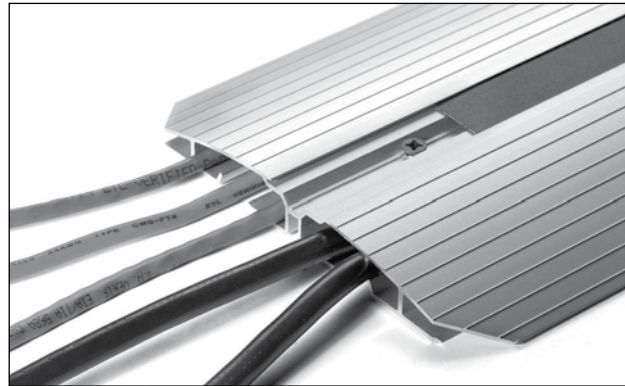

Model #55028

Removable strip exposes attachment screw.

WIRE MANAGEMENT STRIPS

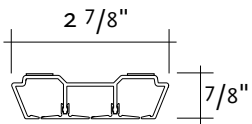

55021
4 pieces

100

A 12" piece of adhesive, low profile, wire management strip.

These can be applied to the underside of the top for light to medium quantities of cabling.

- 12" length.
- Made of black extruded plastic.

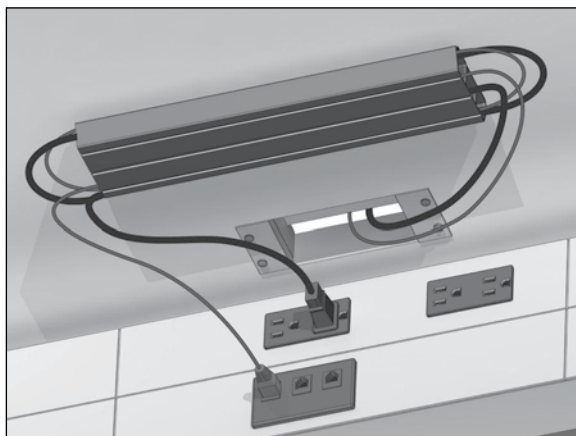

VOX® – HIGH PERFORMANCE SURGE PROTECTOR

DESIGN – MARK MÜLLER

	Model Number	List Price	Product Description
HIGH PERFORMANCE SURGE PROTECTOR	55023	730	<p>This power unit/surge protector totally integrates into the Vox system. It is high quality and provides maximum protection for all advanced and critical electronic, network, and computer applications.</p> <ul style="list-style-type: none">• UL listed, CSA Certified• 33,000 amp surge current protection• 290 volt clamping voltage (actual)• EM1/RFI noise reduction 60db• Lifetime Warranty• power distribution with 6 positions-15amp 120volt• manual on/off switch• power indication light-is lit when power is on• 15 amp overload protector (can be reset when tripped), - if too much equipment is being used and too many amps are being drawn the powerbar will automatically shut off• fail-safe auto shutdown circuitry: the power will be automatically and permanently shutdown once the surge suppression has been consumed• six foot cord length



VOX® CIRCULATION-RECEPTION DESK – HEIGHT ADJUSTABLE ELEMENTS

DESIGN – MARK MÜLLER

The Vox Circulation-Reception desk is available with optional height adjustable tops that are useful in library or corporate settings where intermittent height adjustment is useful. An electrically controlled pair of gear driven legs are housed within the desk base assembly.

The simple up/down control unit is positioned under the front edge of the top for convenient adjustment of the work surface. Sit/stand range is from 29" to 49" tall. Top sizes are limited to a maximum of 66" wide x 32" deep. Height adjustment can also be integrated into curved elements.

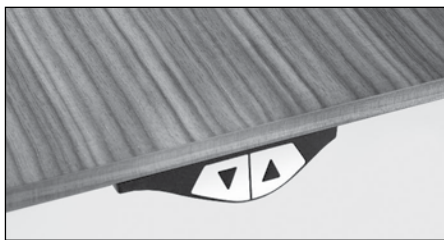
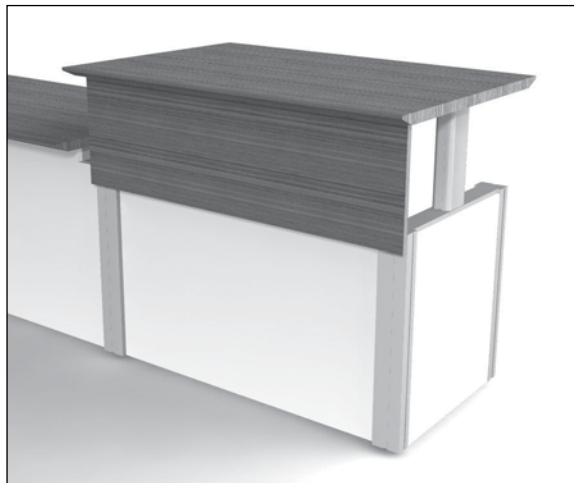
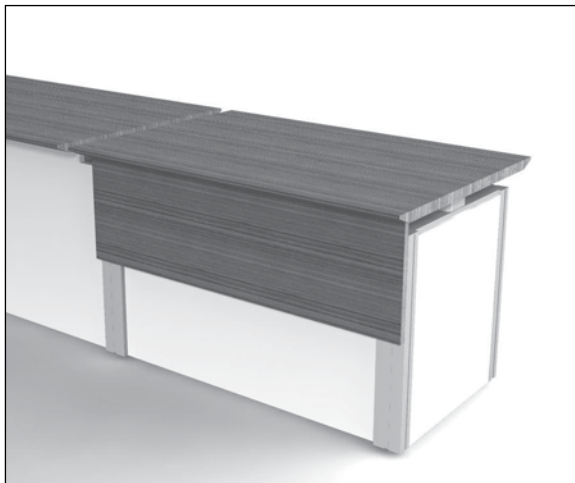

Up/Down Control Unit

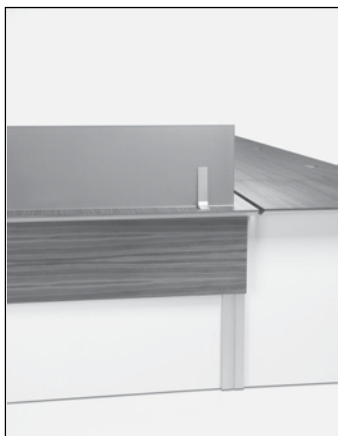

Height Adjustment Range 29" – 49" Tall.

VOX® FILE STORAGE CAPACITY

DESIGN – MARK MÜLLER

Vox storage pedestals accommodate both letter and legal size filing as described in the drawings shown. 18⁵/₈" file drawers include a single file bar that can be used for letter files.

30" and 36" lateral file drawer interiors are manufactured with two solid dividers that can be repositioned to accommodate front to back filing of both letter and legal files. Note: only 36" wide lateral drawers can accommodate 2 rows of front to back legal files.

SINGLE FILE INTERIOR FOR 15³/₄" WIDE FILE PEDESTAL

= 1.28 sq ft of filing

LEGAL FILES

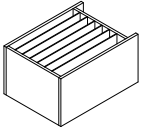

LETTER FILES

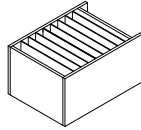

DRAWER SLIDES – CAPACITY

The standard for drawer slides available on Vox®Office™ storage pedestals is a side mount slide. Slide capacity is as follows:

15³/₄" and 18⁵/₈" wide box and file drawer – 110 lbs.

30" and 36" wide lateral file drawer – 150 lbs.

SINGLE FILE INTERIOR FOR 18⁵/₈" WIDE FILE PEDESTAL

= 1.55 sq ft of filing

LEGAL FILES

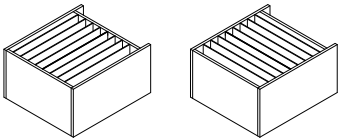

LETTER FILES

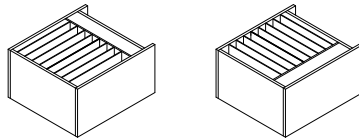

SINGLE FILE INTERIOR FOR 30" WIDE FILE PEDESTAL

= 2.77 sq ft of filing

LEGAL FILES

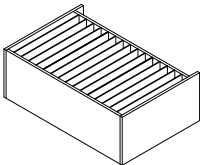

LETTER FILES

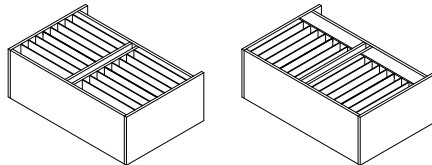

SINGLE FILE INTERIOR FOR 36" WIDE FILE PEDESTAL

= 3.4 sq ft of filing

Note: only 36" wide lateral drawers can accommodate 2 rows of front to back legal files.

LEGAL FILES

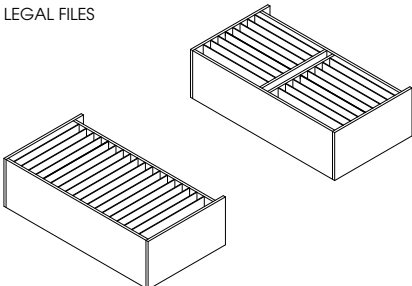

LETTER FILES

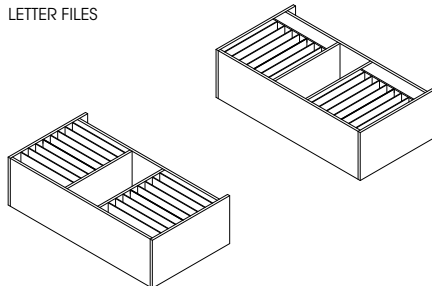

VOX® MOVEABLE PEDESTAL STORAGE

DESIGN – MARK MÜLLER

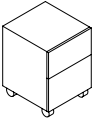
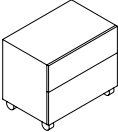
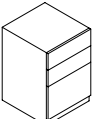
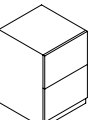
		Model Number	W" x D" x H"			List Price	Product Description
	Box/File with pencil drawer	70249	15 ³ / ₄ "	20"	24 ³ / ₄ "	2,685	<p>Vox® storage pedestals are available in a variety of sizes that accommodate door, box drawer and file drawer storage. The following moveable options for these pedestals are available.</p> <p>All cabinets are paint finish page 12 with fronts available in all standard veneers and finishes page 10.</p> <p>LOCKS Moveable storage units with drawers are standard with face locks that are located on the top right hand corner of the top drawer front.</p> <p>If side mount locks are required as an alternative, they must be specified at time of order. Add \$90.00 list for each change to side mount lock.</p> <p>Moveable storage units with doors are NOT standard with locks. If locks are required, they are positioned in the top corner, opposite to the hinge. Add \$95.00 list per lock. Double doors are locked together with a single lock on the right hand door.</p> <p>DRAWER PULLS Select drawer pull and code from page 25.</p>
		70250/2 With Wood Top	15³/₄"	22¹/₈"	26¹/₂"	3,020	
		70250/5 With Laminate Top	15 ³ / ₄ "	22 ¹ / ₈ "	26 ¹ / ₂ "	2,975	
		70251	18 ⁵ / ₈ "	20"	24 ³ / ₄ "	2,745	
		70255/2 With Wood Top	18⁵/₈"	22¹/₈"	26¹/₂"	3,075	
70255/5 With Laminate Top	18 ⁵ / ₈ "	22 ¹ / ₈ "	26 ¹ / ₂ "	3,045			
	Box/File with pencil drawer	70252	30"	20"	24 ³ / ₄ "	4,045	
		70256/2 With Wood Top	30"	22¹/₈"	26¹/₂"	4,570	
		70256/5 With Laminate Top	30"	22 ¹ / ₈ "	26 ¹ / ₂ "	4,510	
	2 Box/File	70253	18 ⁵ / ₈ "	20"	27 ³ / ₈ "	3,030	
		70257/2 With Wood Top	18⁵/₈"	22¹/₈"	29"	3,360	
		70257/5 With Laminate Top	18 ⁵ / ₈ "	22 ¹ / ₈ "	29"	3,320	
	2 File	70254	18 ⁵ / ₈ "	20"	27 ³ / ₈ "	2,650	
		70258/2 With Wood Top	18⁵/₈"	22¹/₈"	29"	2,975	
		70258/5 With Laminate Top	18 ⁵ / ₈ "	22 ¹ / ₈ "	29"	2,940	



An integrated pencil drawer is included with all 1 box/1file pedestals.



VOX® FILE STORAGE CAPACITY

DESIGN – MARK MÜLLER

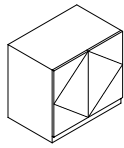

2 Door
1 Adjustable
Shelf

Model Number	W" x D" x H"	List Price	Product Description
70261	30" 20" 27 ³ / ₈ "	3,750	<p>Vox® storage pedestals are available in a variety of sizes that accommodate door, box drawer and file drawer storage. The following moveable options for these pedestals are available.</p> <p>All cabinets are paint finish page 12 with fronts available in all standard veneers and finishes page 10.</p> <p>LOCKS Moveable storage units with drawers are standard with face locks that are located on the top right hand corner of the top drawer front.</p> <p>If side mount locks are required as an alternative, they must be specified at time of order. Add \$90.00 list for each change to side mount lock.</p> <p>Moveable storage units with doors are NOT standard with locks. If locks are required, they are positioned in the top corner, opposite to the hinge. Add \$95.00 list per lock. Double doors are locked together with a single lock on the right hand door.</p> <p>DRAWER PULLS Select drawer pull and code from page 25.</p>
70265/2 With Wood Top	30" 22¹/₈" 29"	4,275	
70265/5 With Laminate Top	30" 22 ¹ / ₈ " 29"	4,225	
70263	36" 20" 27 ³ / ₈ "	4,100	
70267/2 With Wood Top	36" 22¹/₈" 29"	4,680	
70267/5 With Laminate Top	36" 22 ¹ / ₈ " 29"	4,610	
70245	37 ¹ / ₄ " 20" 27 ³ / ₈ "	4,135	
70247/2 With Wood Top	37¹/₄" 22¹/₈" 29"	4,725	
70247/5 With Laminate Top	37 ¹ / ₄ " 22 ¹ / ₈ " 29"	4,665	

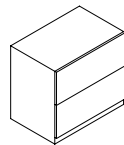

2 File

70262	30" 20" 27 ³ / ₈ "	3,975
70266/2 With Wood Top	30" 22¹/₈" 29"	4,505
70266/5 With Laminate Top	30" 22 ¹ / ₈ " 29"	4,445
70264	36" 20" 27 ³ / ₈ "	4,915
70268/2 With Wood Top	36" 22¹/₈" 29"	5,510
70268/5 With Laminate Top	36" 22 ¹ / ₈ " 29"	5,435
70246	37 ¹ / ₄ " 20" 27 ³ / ₈ "	4,965
70248/2 With Wood Top	37¹/₄" 22¹/₈" 29"	5,555
70248/5 With Laminate Top	37 ¹ / ₄ " 22 ¹ / ₈ " 29"	5,500







An integrated pencil drawer is included with all 1 box/1file pedestals.



VOX® DRAWER/DOOR PULL SPECIFICATIONS

DESIGN – MARK MÜLLER

	Finish	Model Number	L"	x	H" x D"	Product Description
<u>FLUSH PULL – PAINT FINISH</u> 	Silver	FP-S	2"		1 3/4" x 1 1/16"	<p>This flush pull is cast stainless steel and is finished in standard paint finishes to match cabinets. When ordering pulls, add the drawer pull code to the end of the model number of the cabinet selected.</p> <p>Flush pulls are horizontal on credenza fronts, vertical on closet fronts.</p>
	Champagne	FP-C				
	Light Bronze	FP-LB				
<u>FLUSH PULL 2 – PAINT FINISH</u> 	Silver	FP2-S	4 1/2" - 7"		2 1/8" x 3/16"	<p>This flush pull is die cast zinc and is finished in a metallic silver or champagne paint supplied in two sizes scaled to fit the cabinet fronts. When ordering pulls, add the drawer pull code to the end of the model number of the cabinet selected.</p> <p>Flush pulls are horizontal on credenza fronts, vertical on closet fronts.</p>
	Champagne	FP2-C				
<u>SWIVEL PULL – PAINT FINISH</u> 	Silver	SP-S	1 1/8"		1 3/4" x 1 1/16"	<p>The swivel pull is cast stainless steel and is finished in standard paint finishes to match cabinets. When ordering pulls, add the drawer pull code to the end of the model number of the cabinet selected.</p>
	Champagne	SP-C				
	Light Bronze	SP-LB				
<u>BAR PULL – STAINLESS STEEL</u> 	Satin Finish	BP-BSS	13 3/8" - 19 5/8"		3/8" x 1 1/2"	<p>The satin finished stainless steel bar pull is, supplied in two sizes scaled to fit the cabinet fronts. All bar pulls run horizontally on credenza fronts, and vertical on all closet fronts. When ordering pulls, add the drawer pull code to the end of the model number of the cabinet selected.</p>
<u>BAR PULL – ANODIZED ALUMINUM</u> 	Silver	BP-S	14" - 20"		3/8" x 1 1/2"	<p>The aluminum bar pull is supplied in two sizes scaled to fit the cabinet fronts. All bar pulls run horizontally on credenza fronts and vertically on all closet fronts. Available in three standard anodized finishes to match cabinets. When ordering pulls, add the drawer pull code to the end of the model number of the cabinet selected.</p>
	Champagne	BP-C				
	Light Bronze	BP-LB				

VOX® ACCESSORIES FOR ACCESSORY RAIL

DESIGN – MARK MÜLLER

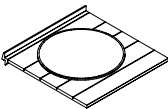
	Finish	Model Number	W" x D" x H"			List Price	Product Description
PAPER CLIP HOLDER 	Silver	70491/S	5"	5"	1/2"	80	<p>The aluminum accessory rail is a 6" high track that attaches directly to the wall or workwall back panel.</p> <p>This range of accessories can personalize the workspace by sliding into the accessory rail and placing where required.</p> <p>Silver anodized finish is standard for accessories, champagne or light bronze finishes are also available.</p>
	Champagne	70491/C					
	Light Bronze	70491/L					

VASE 	Silver	70492/S	2 1/2"	5"	5"	125
	Champagne	70492/C				
	Light Bronze	70492/L				

PHOTO HOLDER 	Silver	70493/S	8"	5"	1/8"	80
	Champagne	70493/C				
	Light Bronze	70493/L				

PENCIL CUP 	Silver	70498/S	5"	5"	3 3/4"	160
	Champagne	70498/C				
	Light Bronze	70498/L				

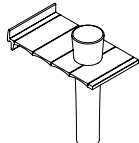
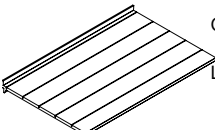
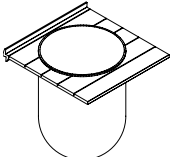
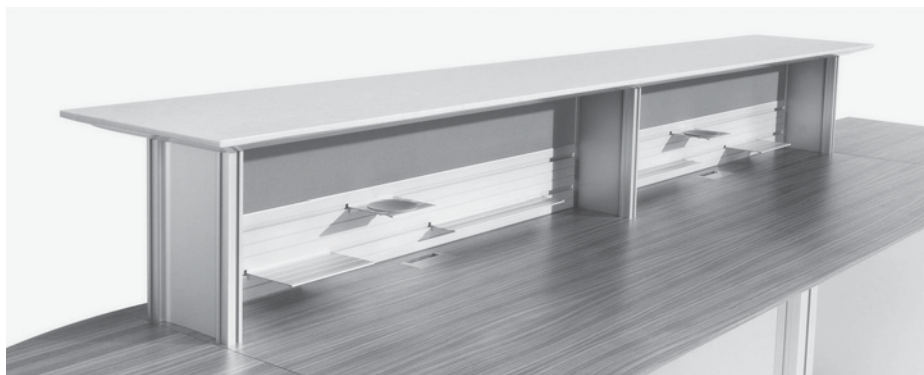

VOX® ACCESSORIES FOR ACCESSORY RAIL

DESIGN - MARK MÜLLER



Paper Clip Holder Accessory Model # 70491



Vase Accessory Model # 70492



Photo Holder Accessory Model # 70493



Pencil Cup Accessory Model # 70498

VOX® ACCESSORIES FOR ACCESSORY RAIL

DESIGN – MARK MÜLLER

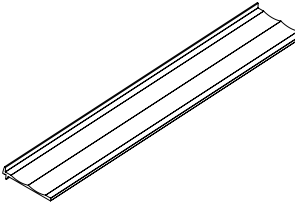
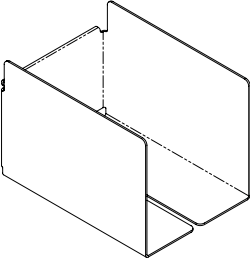
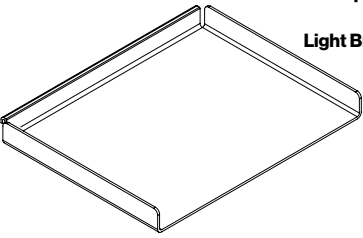
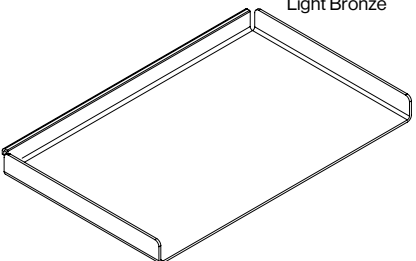
	Finish	Model Number	W" x D" x H"	List Price	Product Description
PENCIL LEDGE 	Silver	70499/S	15 1/2" 2 7/8" 1/8"	85	<p>The aluminum accessory rail is a 6" high track that attaches directly to the wall or workwall back panel.</p> <p>This range of accessories can personalize the workspace by sliding into the accessory rail and placing where required.</p> <p>Silver anodized finish is standard for accessories, champagne or light bronze finishes are also available.</p>
	Champagne	70499/C			
	Light Bronze	70499/L			
VERTICAL BINDER STORAGE 	Silver	70500/S	6" 8 1/2" 6"	250	
	Champagne	70500/C			
	Light Bronze	70500/L			
LETTER TRAY 	Silver	70494/S	12 1/2" 9 1/2" 9 1/2"	210	
	Champagne	70494/C			
	Light Bronze	70494/L			
LEGAL TRAY 	Silver	70495/S	15 1/2" 9 1/2" 1 1/4"	235	
	Champagne	70495/C			
	Light Bronze	70495/L			

VOX® ACCESSORIES FOR ACCESSORY RAIL

DESIGN – MARK MÜLLER

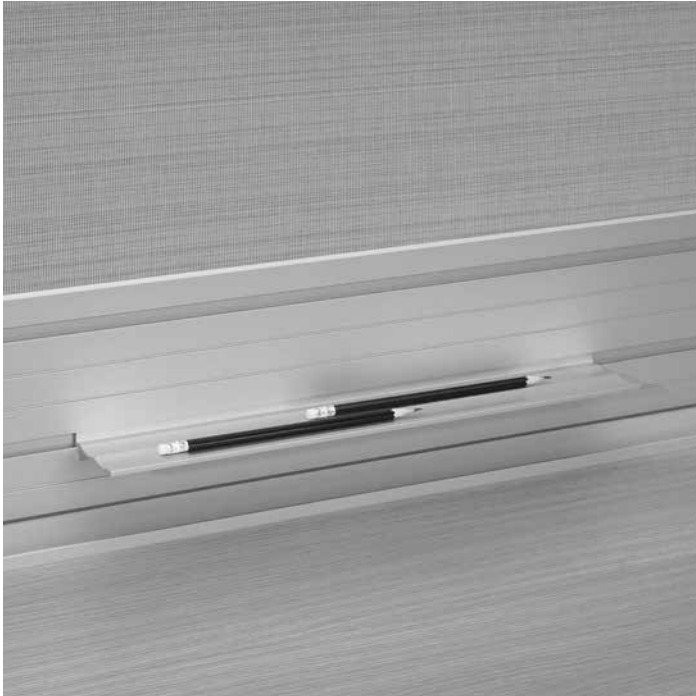

Pencil Ledge Accessory Model # 70499



Vertical Binder Storage Accessory Model # 70500







Letter Tray Accessory Model # 70494



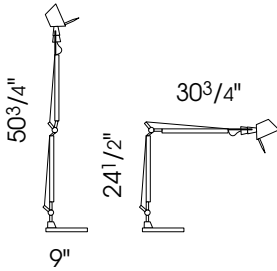
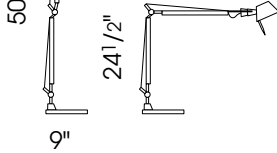
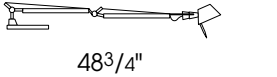

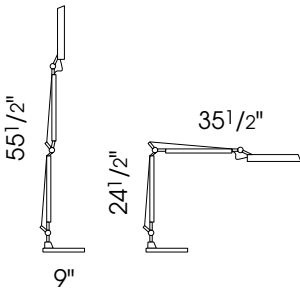
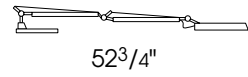
Legal Tray Accessory Model # 70495

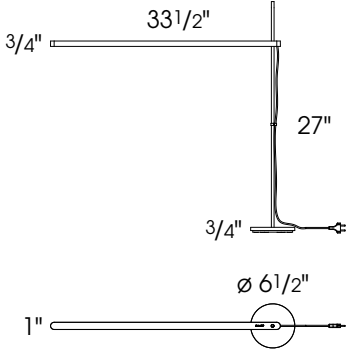
VOX® TASK LIGHTING

	Model Number	W" x D" x H"	List Price	Product Description
<p>TOLOMEO Design: De Lucchi & Fassina</p>  <p>Tolomeo with flush grommet Model 76020 Shown</p>	70611		935	Finished in polished and anodized aluminum. Light Sources: Incandescent A 60 - E 27 100W
	70612		1,475	Halogen capsule QT 12 - GY 6.35 50W/12V
	70613		1,090	Compact fluorescent PL-C-13W/USA 2 Pin BULBS NOT INCLUDED
<p>TOLOMEO VIDEO BODY Design: De Lucchi & Fassina</p>  <p>Video with flush grommet Model 76020 Shown</p>	70615		1,065	Finished in polished and anodized aluminum. Light sources: Compact Fluorescent TC-S_G23 11W
				BULBS NOT INCLUDED
<p>TALAK Design: Neil Poulton</p> 	70616		1,535	Finished in matte white powder coat. Stem finished in polished chrome steel. Light sources: 13W (AXIAL/T2) supplied with fixture Adjustable up and down, rotates 360°

VOX® TASK LIGHTING – BASE OPTIONS

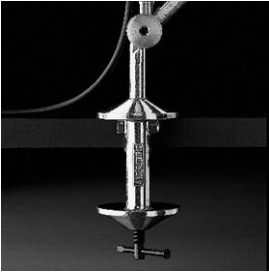
Task lighting can be integrated into tops by a variety of methods. The following mounts can be specified in addition to lamp selections previously made.

	Model Number	W" x D" x H"	List Price	Product Description
TOLOMEO TABLE BASE 	A004030	9" Dia. 2 1/4"	465	The most flexible method of providing task lighting. The lamp can be freely moved to wherever needed. Polished aluminum 9" in diameter Used on Tolomeo and Tolomeo video
TOLOMEO CLAMP MOUNT 	A004100	2 1/2" 4" 4"	155	Can be specified for worktops without pencil stops attached. Polished aluminum Used on Tolomeo and Tolomeo video
TOLOMEO FIXED MOUNT 	A004200	2 1/2" 4" 4"	130	Fixed mount that requires a hole (provided) in the work surface. Polished aluminum Used on Tolomeo and Tolomeo video
TOLOMEO FLUSH GROMMET MOUNT 	70620	1 1/16" dia. 4" 1 1/8"	235	Flush grommet that requires a hole (provided) in the work surface. Polished aluminum. Lamp cord is spliced for installation, cord is completely hidden

VOX® MONITOR SUPPORTS

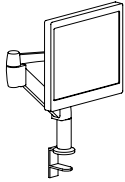
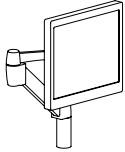
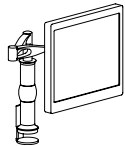
	Model Number	D" x H" x	Angle	List Price	Product Description
	70605 Clamp Mounting	4"-22" x 0"-14"	359°	1,470	Accommodating to Vesa 75mm and 100mm mounting patterns. Adjustable with out the use of tools. Pneumatic counterbalance for monitors 7lbs. to 22lbs. Available in a clamp mount and a bolt through mount.
	70604 Bolt Through Mounting	4"-22" x 0"-14"	359°	1,300	Platinum finish.
	70645 Clamp or Bolt Mounting	4"-18" x 13"-17"	360°	705	Accommodating to Vesa 75mm and 100mm mounting patterns. Adjustable with out the use of tools. Comes standard with clamp mount and a bolt through mount. Silver finish.

VOX® MONITOR SUPPORTS

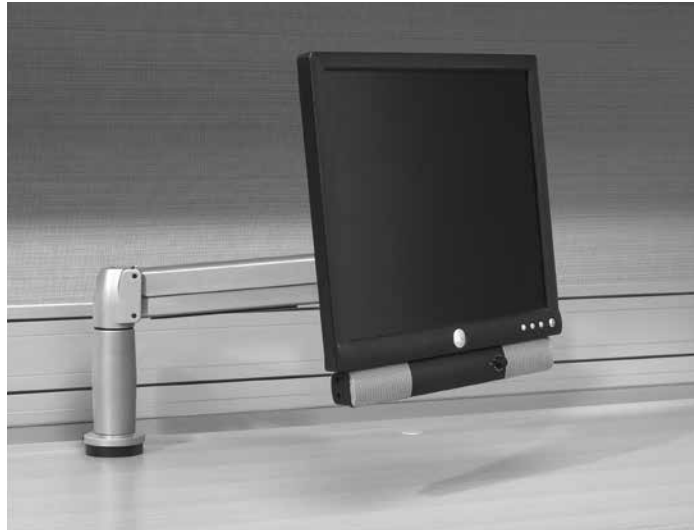

Clamp mount model # 70605



Clamp Mount model # 70645

VOX® CPU HOLDERS

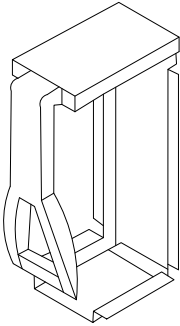
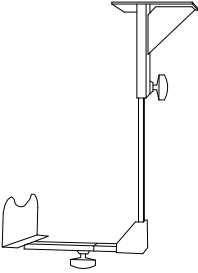
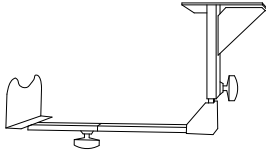
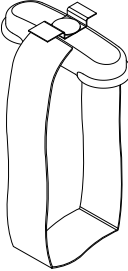
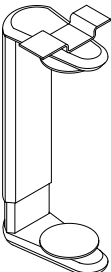
	Model Number	W" x D" x H"			List Price	Product Description
CPU HOLDER	70631	10"	7"	17"	380	Accommodating CPU vertically this unit is fully adjustable and swivels 360 degrees. It adjusts to fit CPU from 3" to 9" wide by 15" to 24" high. CPU must be positioned vertically. Black Finish
						
CPU HOLDER	70632	Width and depth as per notes, 10" deep			140	CPU can be accommodated both horizontally or vertically with this unit. Adjusts to fit horizontal CPU from: 14" - 18" wide by 7" - 11" high Adjusts to fit vertical CPU from: 5" - 9" wide by 15" - 19" high. Black finish
						
Vertical						
						
Horizontal						
LOOP CPU HOLDER	70636	12"	4"	3"	480	The Loop supports the CPU with webbing, which is tightened by a ratchet mechanism. Adjust to fit CPU from 3 ³ / ₄ " x 8 ¹ / ₄ " wide by 11 ¹ / ₂ " x 19 ¹ / ₂ " high Black finish
						
JAW CPU HOLDER	70637	8"	4"	15" - 23"	685	The Jaw allows the CPU to float below the desk. Constructed from die cast and extruded aluminum. Adjust to fit CPU from 3 ³ / ₄ " x 9 ³ / ₄ " wide by 11 ¹ / ₂ " x 20" high Silver finish
						



Model # 70631



Model # 70632



Model # 70636



Model # 70637

VOX® KEYBOARD SUPPORTS

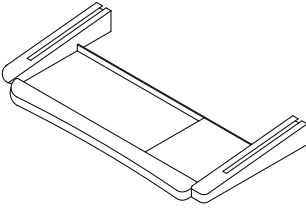
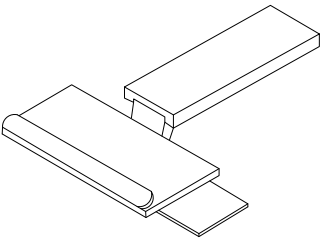
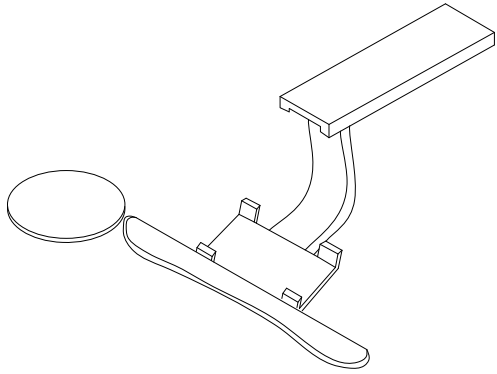
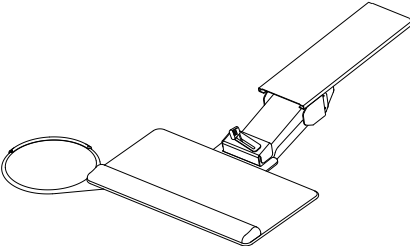
	Model Number	W" x D" x H"			List Price	Product Description
<p>KEYBOARD DRAWER</p> 	70641	30"	20"	4"	590	This keyboard drawer integrates areas for both keyboard and mouse pad. A gel pad provides a soft comfortable wrist rest area. The keyboard platform offers three typing positions for maximum comfort. Fully concealed full extension slides. Built in cable management.
<p>KEYBOARD SUPPORT</p> 	70642	21"	18"	8 1/2"	785	This keyboard support has a spring assisted height adjustment mechanism with a lever lock. 25-degree tilt adjustment, 360 degree swivel. Actual keyboard tray 8 1/4" deep x 19 3/4" long, mouse pad is universal left or right positioning. Full-length urethane wrist rest.
<p>KEYBOARD SUPPORT</p> 	70643				1,160	This keyboard support is actually a clamp device that holds the keyboard in place. It includes a gel palm rest and adjustable mouse pad that can be moved left or right. The spring assisted arm makes knobs and handles unnecessary for adjustment. Keyboard tilt is +10/-20 degrees. Adjustment is from 6 1/2" above the worktop to 6" below.
<p>KEYBOARD SUPPORT</p> 	70644	19"	21"	6"	470	This keyboard support has a spring assisted height adjustment ranging from 1 1/4" above work surface to 5" below. Platform tilt 0 degree to -15 degree. Actual keyboard tray 10 1/2" deep x 19" long with a full length urethane wrist rest. Mouse pad is universal left or right positioning.

VOX® KEYBOARD SUPPORTS



Model # 70641



Model # 70642



Model # 70643



Model # 70644

VOX® STORAGE ACCESSORIES – UNDER WORK SURFACE

	Model Number	W" x D" x H"			List Price	Product Description
LARGE PENCIL DRAWER	70296	23"	18"	3"	160	Large pencil drawer made of black plastic with side mount slides. Can be positioned under any work surface.
						
STORAGE DRAWER	70297	19 1/4"	23"	2 1/4"/10"	835	<p>A large storage drawer that attaches to the underside of work tops that are 27" or 30" deep.</p> <p>Removable bars in the back section of the drawer accommodate both letter and legal filing. With bars removed a large area is available as storage for a variety of items including a purse, or shoes etcetera.</p> <p>The front section of the drawer can be used as a pencil tray with a variety of areas for miscellaneous work related items.</p> <p>The padded drawer front has an integrated locking system.</p>
						

VOX® CIRCULATION-RECEPTION DESK – CONFIGURATIONS

DESIGN – MARK MÜLLER

DESK 01

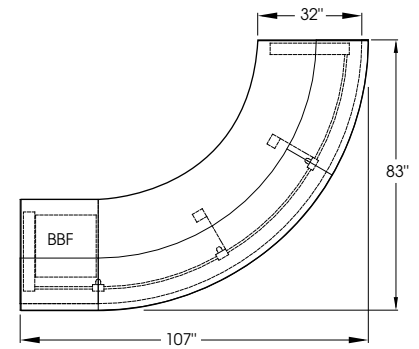

PLAN VIEW

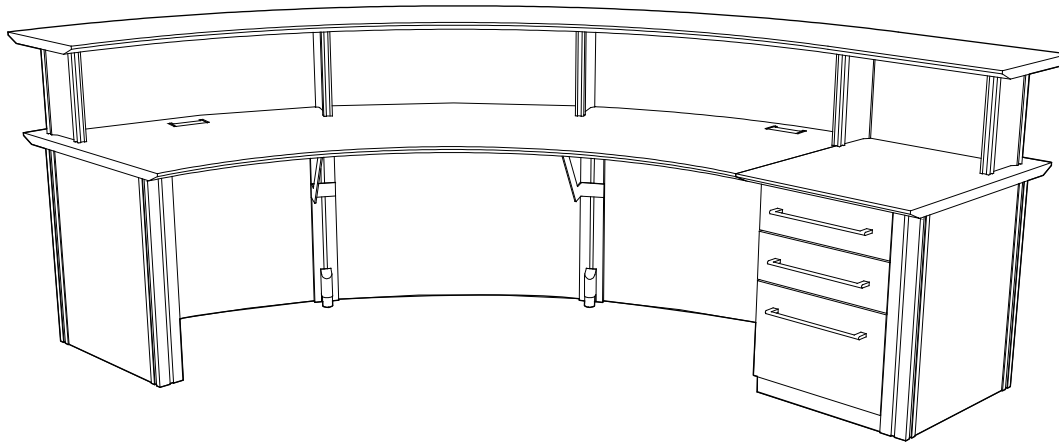

Image shown with – but not included in standard pricing:

- Option 2
- Taper edge profile
- 1 Pedestal with 2 box 1 file storage

FEATURES	STANDARD	OPTION 1	LIST PRICES	OPTION 2	LIST PRICES
TOP SURFACE	PLASTIC LAMINATE	VENEER	775	STONE	7,740
EDGE PROFILE	SELF EDGE	FACET EDGE	no charge	TAPER EDGE	no charge
GALLERY TOP FINISH	PLASTIC LAMINATE	VENEER	555	STONE	3,830
MODESTY / BASE PANEL FINISH	PLASTIC LAMINATE	VENEER	945		
PARTIAL MODESTY FEATURE	PLASTIC LAMINATE	VENEER	n/a		
ALUMINUM COMPONENTS FINISH	CLEAR ANODIZED	CHAMPAGNE ANODIZED	no charge	LT. BRONZE ANODIZED	no charge
GALLERY / PRIVACY SCREEN FINISH	PLASTIC LAMINATE	VENEER	325		
STORAGE ELEMENTS	NONE	1 BOX / 1 FILE MOBILE (qty=1)	2,685	2 BOX / 1 FILE MOVABLE (qty=1)	3,030
POWER / VOICE / DATA OPTION	NONE	2 DUPLEX / 1 VOICE & 1 DATA	2,420	3 DUPLEX / 1 VOICE / 1 DATA	2,610
GROMMETS	PLASTIC 4" X 2" #70286	ALUMINUM 5" X 2.25" #70277	280	ALUMINUM 8" X 4.5" #70830	545
BOOK DROP	NONE	BOOK DROP	245	BOOK DROP + CART (P/L)	2,640
HEIGHT ADJUSTABLE ELEMENTS	NONE				
DESKTOP ACCESSORIES	NONE	LG PENCIL TRAY #70296	150	LG. PENCIL TRAY #70296	160
COMPUTER ACCESSORIES	NONE	CPU HOLDER #70632	140	CPU HOLDER #70637	685
TOTAL	\$20,665 LIST - PLUS				
	OPTIONS				

VOX® CIRCULATION-RECEPTION DESK – CONFIGURATIONS

DESIGN – MARK MÜLLER

DESK 02

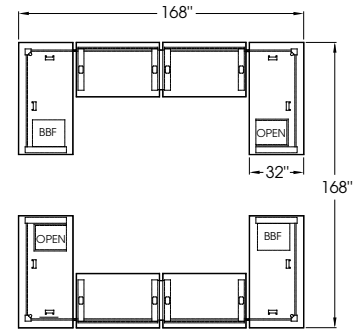
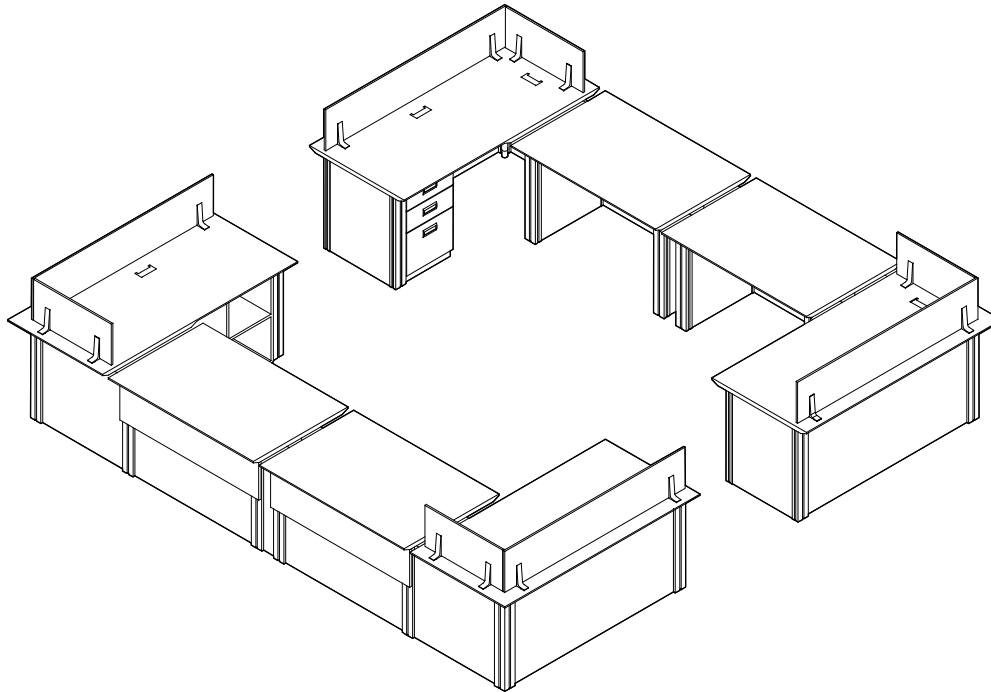

PLAN VIEW

Image shown with – but not included in standard pricing:

- Option 1
4 Electric lift elements
- Option 2
Taper edge profile
2 Pedestals with 2 box 1 file storage
- Custom
2 Open storage units

FEATURES	STANDARD	OPTION 1	LIST PRICES	OPTION 2	LIST PRICES
TOP SURFACE	PLASTIC LAMINATE	VENEER	1,625	STONE	10,220
EDGE PROFILE	SELF EDGE	FACET EDGE	no charge	TAPER EDGE	no charge
GALLERY TOP FINISH	PLASTIC LAMINATE	VENEER	n/a	STONE	n/a
MODESTY / BASE PANEL FINISH	PLASTIC LAMINATE	VENEER	2,860		
PARTIAL MODESTY FEATURE	PLASTIC LAMINATE	VENEER	235		
ALUMINUM COMPONENTS FINISH	CLEAR ANODIZED	CHAMPAGNE ANODIZED	no charge	LT. BRONZE ANODIZED	no charge
GALLERY / PRIVACY SCREEN FINISH	PLASTIC LAMINATE	VENEER	845	GLASS	1,825
STORAGE ELEMENTS	NONE	1 BOX / 1 FILE MOBILE (qty=1)	2,685	2 BOX / 1 FILE MOVABLE (qty=1)	3,030
POWER / VOICE / DATA OPTION	NONE	2 DUPLEX / 1 VOICE & 1 DATA	2,615	3 DUPLEX / 1 VOICE / 1 DATA	2,810
GROMMETS	PLASTIC 4" X 2" #70286	ALUMINUM 5" X 2.25" #70277	280	ALUMINUM 8" X 4.5" #70830	545
BOOK DROP	NONE	BOOK DROP	245	BOOK DROP + CART (P/L)	2,640
HEIGHT ADJUSTABLE ELEMENTS	NONE	ELECTRIC LIFT ELEMENT	2,590		
DESKTOP ACCESSORIES	NONE	LG PENCIL TRAY #70296	150	LG. PENCIL TRAY #70296	160
COMPUTER ACCESSORIES	NONE	CPU HOLDER #70632	140	CPU HOLDER #70637	685
TOTAL	\$47,600 LIST - PLUS OPTIONS				

VOX® CIRCULATION-RECEPTION DESK – CONFIGURATIONS

DESIGN – MARK MÜLLER

DESK 03

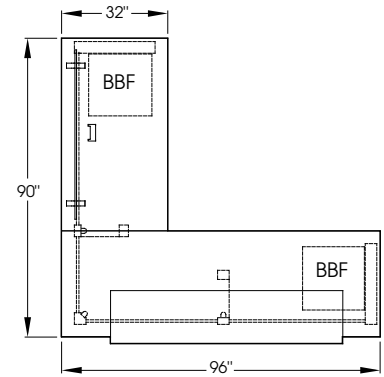

PLAN VIEW

Image shown with – but not included in standard pricing:

Option 1
Power/Voice/Data

Option 2
Taper edge profile
2 Pedestals with 2 box 1 file storage

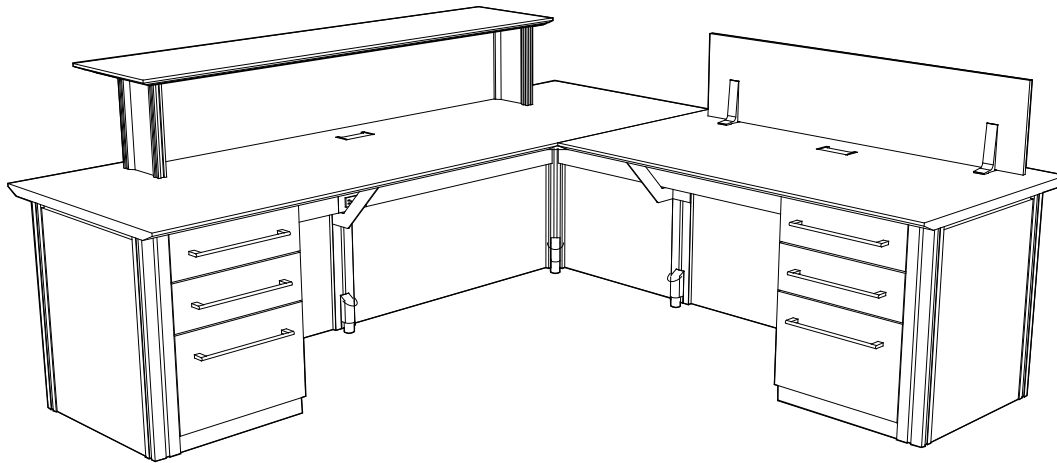

FEATURES	STANDARD	OPTION 1	LIST PRICES	OPTION 2	LIST PRICES
TOP SURFACE	PLASTIC LAMINATE	VENEER	745	STONE	7,740
EDGE PROFILE	SELF EDGE	FACET EDGE	no charge	TAPER EDGE	no charge
GALLERY TOP FINISH	PLASTIC LAMINATE	VENEER	335	STONE	1,635
MODESTY / BASE PANEL FINISH	PLASTIC LAMINATE	VENEER	1,130		
PARTIAL MODESTY FEATURE	PLASTIC LAMINATE	VENEER	235		
ALUMINUM COMPONENTS FINISH	CLEAR ANODIZED	CHAMPAGNE ANODIZED	no charge	LT. BRONZE ANODIZED	no charge
GALLERY / PRIVACY SCREEN FINISH	PLASTIC LAMINATE	VENEER	235	GLASS	725
STORAGE ELEMENTS	NONE	1 BOX / 1 FILE MOBILE (qty=1)	2,685	2 BOX / 1 FILE MOVABLE (qty=1)	3,030
POWER / VOICE / DATA OPTION	NONE	2 DUPLEX / 1 VOICE & 1 DATA	2,615	3 DUPLEX / 1 VOICE / 1 DATA	2,810
GROMMETS	PLASTIC 4" X 2" #70286	ALUMINUM 5" X 2.25" #70277	280	ALUMINUM 8" X 4.5" #70830	545
BOOK DROP	NONE	BOOK DROP	245	BOOK DROP + CART (P/L)	2,640
HEIGHT ADJUSTABLE ELEMENTS	NONE	ELECTRIC LIFT ELEMENT	n/a		
DESKTOP ACCESSORIES	NONE	LG PENCIL TRAY #70296	150	LG. PENCIL TRAY #70296	160
COMPUTER ACCESSORIES	NONE	CPU HOLDER #70632	140	CPU HOLDER #70637	685
TOTAL	\$13,825 LIST - PLUS OPTIONS				

VOX® CIRCULATION-RECEPTION DESK – CONFIGURATIONS

DESIGN – MARK MÜLLER

DESK 04

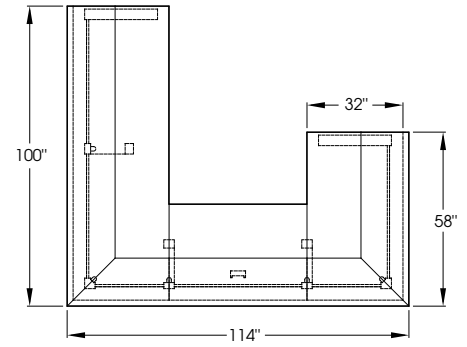

PLAN VIEW

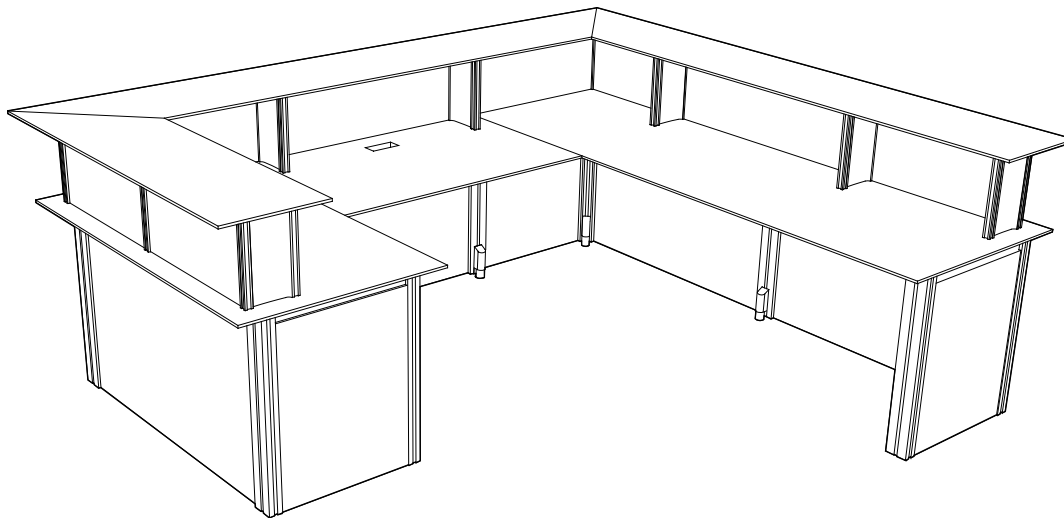

Image shown with – but not included in standard pricing:

Option 2
Taper edge profile

FEATURES	STANDARD	OPTION 1	LIST PRICES	OPTION 2	LIST PRICES
TOP SURFACE	PLASTIC LAMINATE	VENEER	965	STONE	9,545
EDGE PROFILE	SELF EDGE	FACET EDGE	no charge	TAPER EDGE	no charge
GALLERY TOP FINISH	PLASTIC LAMINATE	VENEER	845	STONE	7,280
MODESTY / BASE PANEL FINISH	PLASTIC LAMINATE	VENEER	1,480		
PARTIAL MODESTY FEATURE	PLASTIC LAMINATE	VENEER	235		
ALUMINUM COMPONENTS FINISH	CLEAR ANODIZED	CHAMPAGNE ANODIZED	no charge	LT. BRONZE ANODIZED	no charge
GALLERY / PRIVACY SCREEN FINISH	PLASTIC LAMINATE	VENEER	745	GLASS	1,570
STORAGE ELEMENTS	NONE	1 BOX / 1 FILE MOBILE (qty=1)	2,685	2 BOX / 1 FILE MOVABLE (qty=1)	3,030
POWER / VOICE / DATA OPTION	NONE	2 DUPLEX / 1 VOICE & 1 DATA	2,615	3 DUPLEX / 1 VOICE / 1 DATA	2,810
GROMMETS	PLASTIC 4" X 2" #70286	ALUMINUM 5" X 2.25" #70277	280	ALUMINUM 8" X 4.5" #70830	545
BOOK DROP	NONE	BOOK DROP	245	BOOK DROP + CART (P/L)	2,640
HEIGHT ADJUSTABLE ELEMENTS	NONE	ELECTRIC LIFT ELEMENT	n/a		
DESKTOP ACCESSORIES	NONE	LG PENCIL TRAY #70296	150	LG. PENCIL TRAY #70296	160
COMPUTER ACCESSORIES	NONE	CPU HOLDER #70632	140	CPU HOLDER #70637	685
TOTAL	\$21,950 LIST - PLUS				
	OPTIONS				

VOX® CIRCULATION-RECEPTION DESK – CONFIGURATIONS

DESIGN – MARK MÜLLER

DESK 05

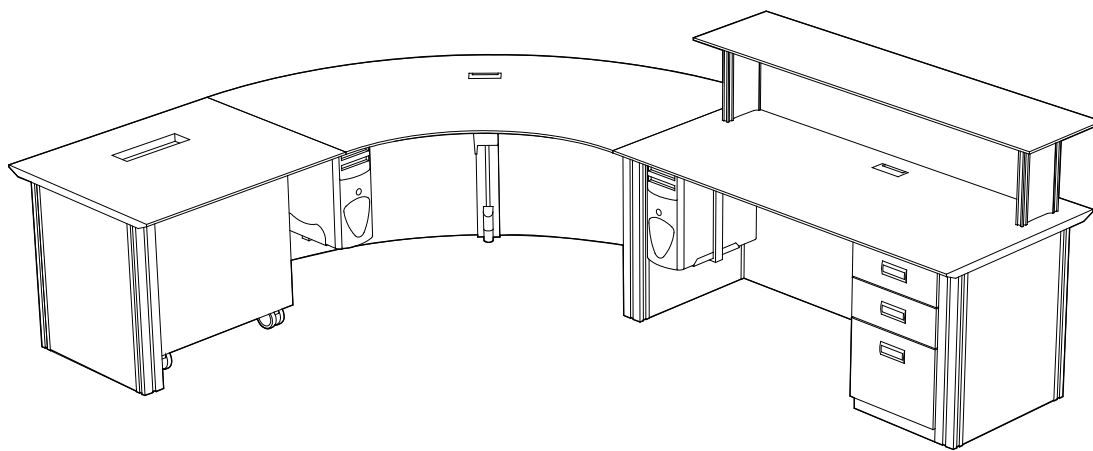
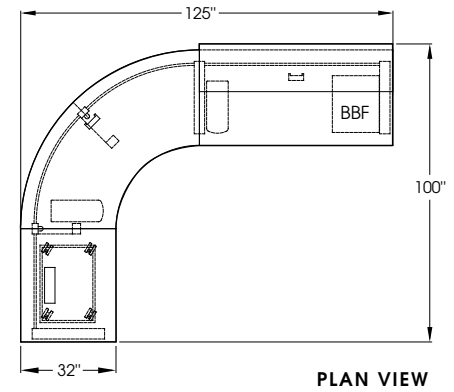

Image shown with – but not included in standard pricing:

- Option 1
2 CPU holders
- Option 2
Taper edge profile
1 Book Drop + Cart
1 Pedestal with 2 box 1 file storage

FEATURES	STANDARD	OPTION 1	LIST PRICES	OPTION 2	LIST PRICES
TOP SURFACE	PLASTIC LAMINATE	VENEER	1,515	STONE	10,505
EDGE PROFILE	SELF EDGE	FACET EDGE	no charge	TAPER EDGE	no charge
GALLERY TOP FINISH	PLASTIC LAMINATE	VENEER	470	STONE	1,635
MODESTY / BASE PANEL FINISH	PLASTIC LAMINATE	VENEER	1,515		
PARTIAL MODESTY FEATURE	PLASTIC LAMINATE	VENEER	235		
ALUMINUM COMPONENTS FINISH	CLEAR ANODIZED	CHAMPAGNE ANODIZED	no charge	LT. BRONZE ANODIZED	no charge
GALLERY / PRIVACY SCREEN FINISH	PLASTIC LAMINATE	VENEER	235	GLASS	440
STORAGE ELEMENTS	NONE	1 BOX / 1 FILE MOBILE (qty=1)	2,685	2 BOX / 1 FILE MOVABLE (qty=1)	3,030
POWER / VOICE / DATA OPTION	NONE	2 DUPLEX / 1 VOICE & 1 DATA	2,615	3 DUPLEX / 1 VOICE / 1 DATA	2,810
GROMMETS	PLASTIC 4" X 2" #70286	ALUMINUM 5" X 2.25" #70277	280	ALUMINUM 8" X 4.5" #70830	545
BOOK DROP	NONE	BOOK DROP	245	BOOK DROP + CART (P/L)	2,640
HEIGHT ADJUSTABLE ELEMENTS	NONE	ELECTRIC LIFT ELEMENT	2,590		
DESKTOP ACCESSORIES	NONE	LG PENCIL TRAY #70296	150	LG. PENCIL TRAY #70296	160
COMPUTER ACCESSORIES	NONE	CPU HOLDER #70632	140	CPU HOLDER #70637	685
TOTAL	\$17,600 LIST - PLUS OPTIONS				

VOX® CIRCULATION-RECEPTION DESK – CONFIGURATIONS

DESIGN – MARK MÜLLER

DESK 06

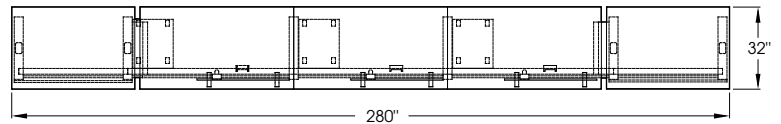

PLAN VIEW

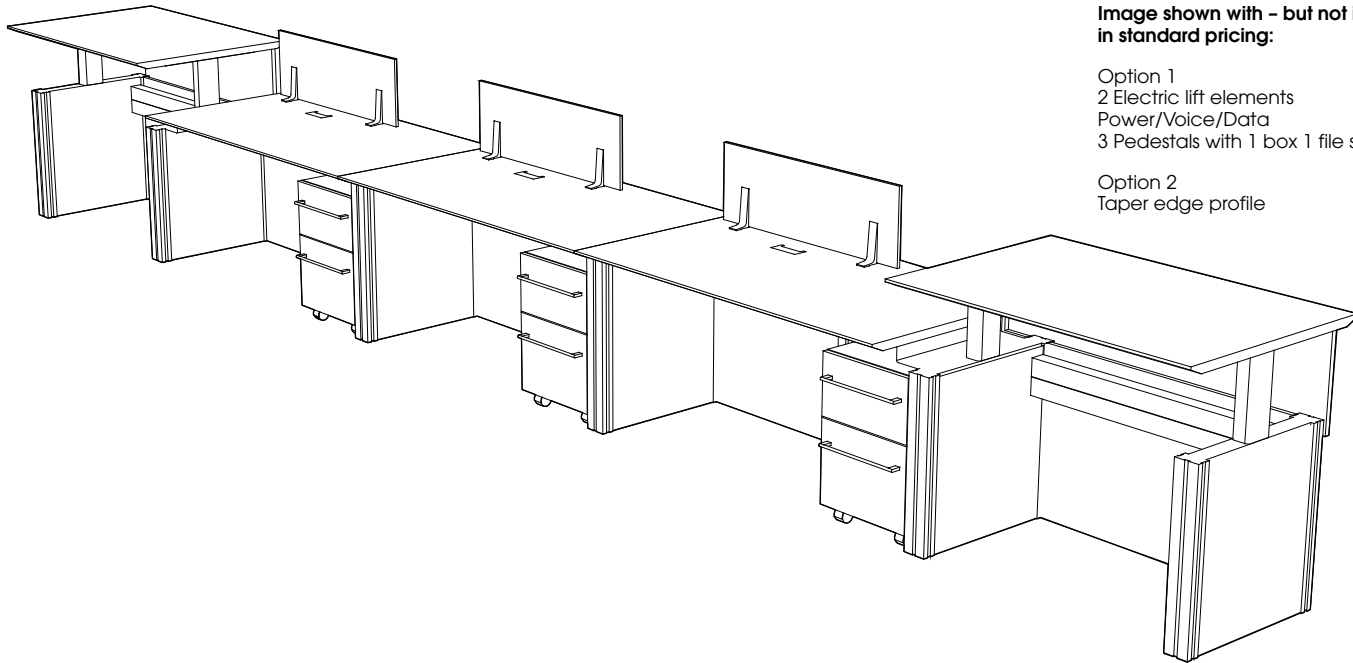

Image shown with – but not included in standard pricing:

Option 1
2 Electric lift elements
Power/Voice/Data
3 Pedestals with 1 box 1 file storage

Option 2
Taper edge profile

FEATURES	STANDARD	OPTION 1	LIST PRICES	OPTION 2	LIST PRICES
TOP SURFACE	PLASTIC LAMINATE	VENEER	1,595	STONE	10,055
EDGE PROFILE	SELF EDGE	FACET EDGE	no charge	TAPER EDGE	no charge
GALLERY TOP FINISH	PLASTIC LAMINATE	VENEER	n/a	STONE	n/a
MODESTY / BASE PANEL FINISH	PLASTIC LAMINATE	VENEER	1,495		
PARTIAL MODESTY FEATURE	PLASTIC LAMINATE	VENEER	320		
ALUMINUM COMPONENTS FINISH	CLEAR ANODIZED	CHAMPAGNE ANODIZED	no charge	LT. BRONZE ANODIZED	no charge
GALLERY / PRIVACY SCREEN FINISH	PLASTIC LAMINATE	VENEER	235	GLASS	695
STORAGE ELEMENTS	NONE	1 BOX / 1 FILE MOBILE (qty=1)	2,685	2 BOX / 1 FILE MOVABLE (qty=1)	3,030
POWER / VOICE / DATA OPTION	NONE	2 DUPLEX / 1 VOICE & 1 DATA	3,915	3 DUPLEX / 1 VOICE / 1 DATA	4,205
GROMMETS	PLASTIC 4" X 2" #70286	ALUMINUM 5" X 2.25" #70277	280	ALUMINUM 8" X 4.5" #70830	545
BOOK DROP	NONE	BOOK DROP	245	BOOK DROP + CART (P/L)	2,640
HEIGHT ADJUSTABLE ELEMENTS	NONE	ELECTRIC LIFT ELEMENT	2,590		
DESKTOP ACCESSORIES	NONE	LG PENCIL TRAY #70296	150	LG. PENCIL TRAY #70296	160
COMPUTER ACCESSORIES	NONE	CPU HOLDER #70632	140	CPU HOLDER #70637	685
TOTAL	\$18,420 LIST - PLUS OPTIONS				

VOX® CIRCULATION-RECEPTION DESK – CONFIGURATIONS

DESIGN – MARK MÜLLER

DESK 07

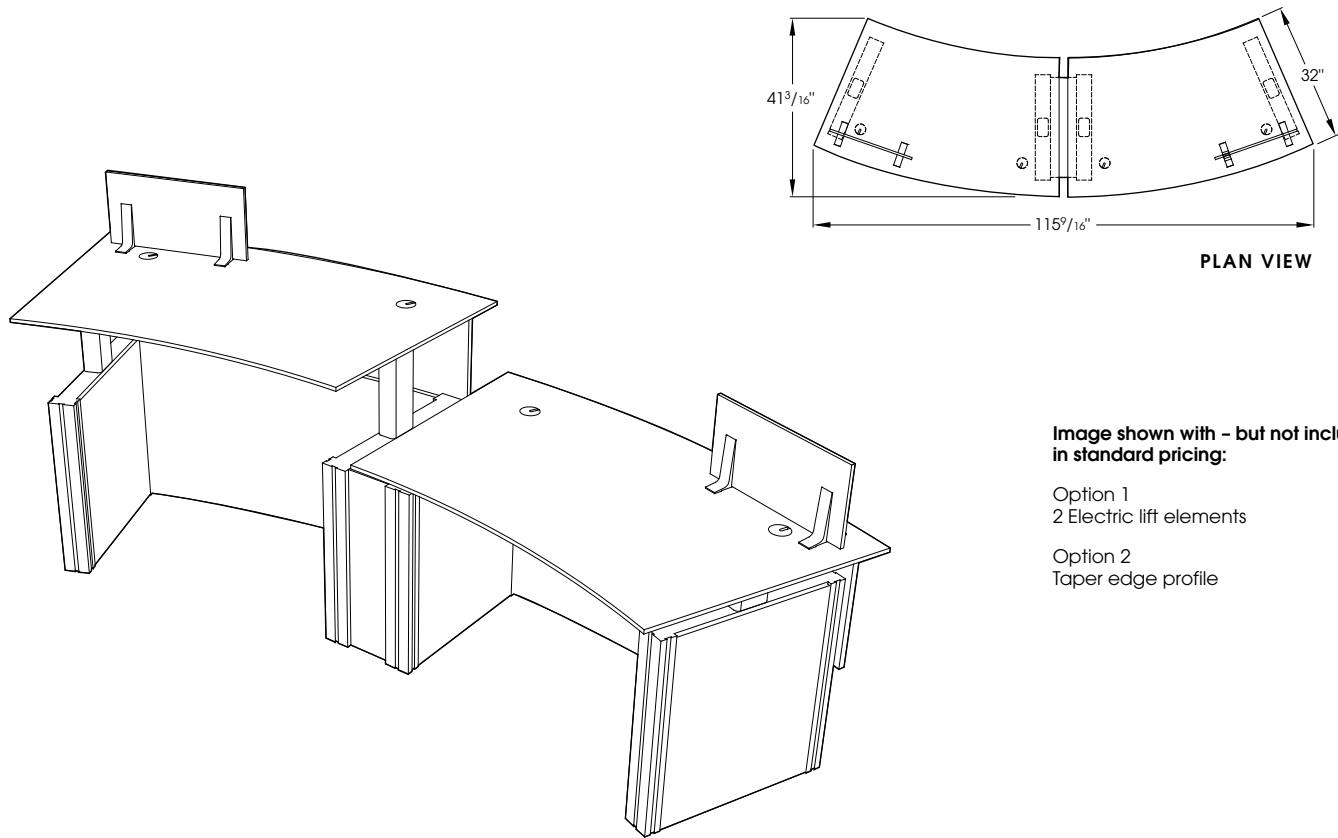

Image shown with – but not included in standard pricing:

Option 1
2 Electric lift elements

Option 2
Taper edge profile

FEATURES	STANDARD	OPTION 1	LIST PRICES	OPTION 2	LIST PRICES
TOP SURFACE	PLASTIC LAMINATE	VENEER	960	STONE	2,795
EDGE PROFILE	SELF EDGE	FACET EDGE	no charge	TAPER EDGE	no charge
GALLERY TOP FINISH	PLASTIC LAMINATE	VENEER	n/a	STONE	n/a
MODESTY / BASE PANEL FINISH	PLASTIC LAMINATE	VENEER	835		
PARTIAL MODESTY FEATURE	PLASTIC LAMINATE	VENEER	440		
ALUMINUM COMPONENTS FINISH	CLEAR ANODIZED	CHAMPAGNE ANODIZED	no charge	LT. BRONZE ANODIZED	no charge
GALLERY / PRIVACY SCREEN FINISH	PLASTIC LAMINATE	VENEER	160	GLASS	410
STORAGE ELEMENTS	NONE	1 BOX / 1 FILE MOBILE (qty=1)	2,685	2 BOX / 1 FILE MOVABLE (qty=1)	3,030
POWER / VOICE / DATA OPTION	NONE	2 DUPLEX / 1 VOICE & 1 DATA	1,315	3 DUPLEX / 1 VOICE / 1 DATA	1,415
GROMMETS	PLASTIC 4" X 2" #70286	ALUMINUM 5" X 2.25" #70277	280	ALUMINUM 8" X 4.5" #70830	545
BOOK DROP	NONE	BOOK DROP	245	BOOK DROP + CART (P/L)	2,640
HEIGHT ADJUSTABLE ELEMENTS	NONE	ELECTRIC LIFT ELEMENT	2,590		
DESKTOP ACCESSORIES	NONE	LG PENCIL TRAY #70296	150	LG. PENCIL TRAY #70296	160
COMPUTER ACCESSORIES	NONE	CPU HOLDER #70632	140	CPU HOLDER #70637	685
TOTAL	\$13,915 LIST - PLUS OPTIONS				

VOX® CIRCULATION-RECEPTION DESK – CONFIGURATIONS

DESIGN – MARK MÜLLER

DESK 08

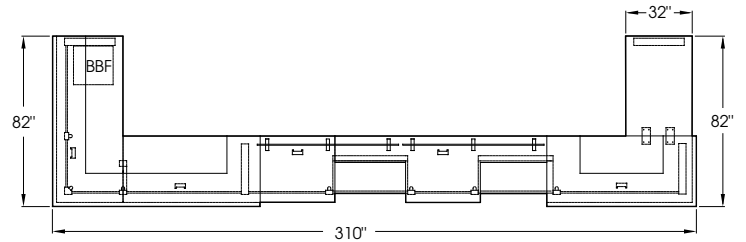

PLAN VIEW

Image shown with:

Option 2
2 Pedestals with 2 box 1 file storage
Taper edge profile

Custom
2 Pedestals with single lateral file drawer

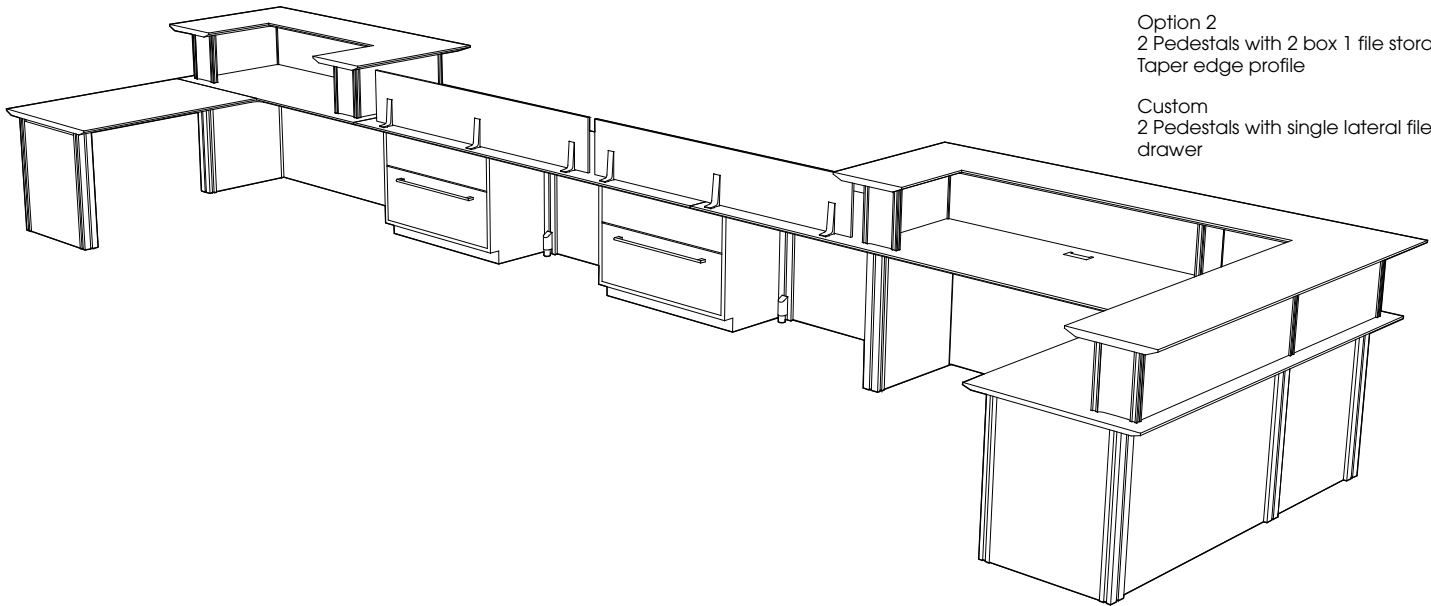

FEATURES	STANDARD	OPTION 1	LIST PRICES	OPTION 2	LIST PRICES
TOP SURFACE	PLASTIC LAMINATE	VENEER	1,455	STONE	10,925
EDGE PROFILE	SELF EDGE	FACET EDGE	no charge	TAPER EDGE	no charge
GALLERY TOP FINISH	PLASTIC LAMINATE	VENEER	1,055	STONE	7,685
MODESTY / BASE PANEL FINISH	PLASTIC LAMINATE	VENEER	2,420		
PARTIAL MODESTY FEATURE	PLASTIC LAMINATE	VENEER	440		
ALUMINUM COMPONENTS FINISH	CLEAR ANODIZED	CHAMPAGNE ANODIZED	no charge	LT. BRONZE ANODIZED	no charge
GALLERY / PRIVACY SCREEN FINISH	PLASTIC LAMINATE	VENEER	1,100	GLASS	1,470
STORAGE ELEMENTS	NONE	1 BOX / 1 FILE MOBILE (qty=1)	2,685	2 BOX / 1 FILE MOVABLE (qty=1)	3,030
POWER / VOICE / DATA OPTION	NONE	2 DUPLEX / 1 VOICE & 1 DATA	5,210	3 DUPLEX / 1 VOICE / 1 DATA	5,595
GROMMETS	PLASTIC 4" X 2" #70286	ALUMINUM 5" X 2.25" #70277	280	ALUMINUM 8" X 4.5" #70830	545
BOOK DROP	NONE	BOOK DROP	245	BOOK DROP + CART (P/L)	2,640
HEIGHT ADJUSTABLE ELEMENTS	NONE	ELECTRIC LIFT ELEMENT	2,590		
DESKTOP ACCESSORIES	NONE	LG PENCIL TRAY #70296	150	LG. PENCIL TRAY #70296	160
COMPUTER ACCESSORIES	NONE	CPU HOLDER #70632	140	CPU HOLDER #70637	685
TOTAL	\$38,975 LIST - PLUS				
	OPTIONS				

VOX® CIRCULATION-RECEPTION DESK – CONFIGURATIONS

DESIGN – MARK MÜLLER

DESK 09

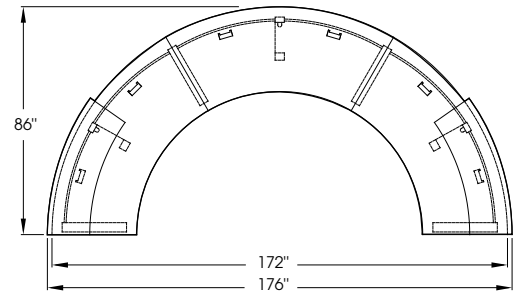
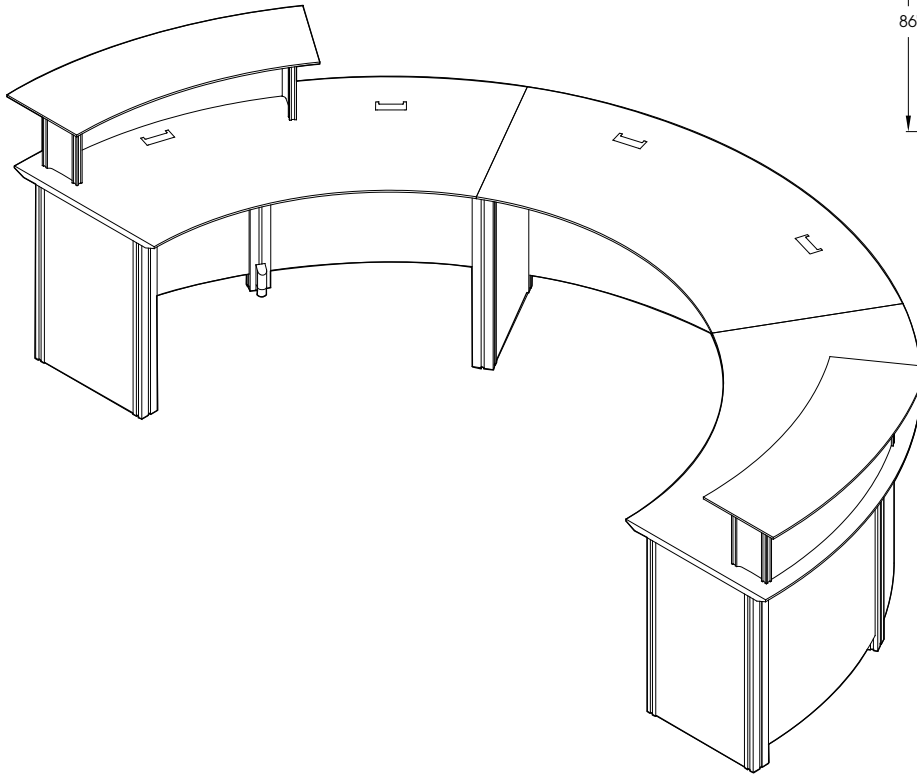

PLAN VIEW

Image shown with:

Option 2
Taper edge profile

FEATURES	STANDARD	OPTION 1	LIST PRICES	OPTION 2	LIST PRICES
TOP SURFACE	PLASTIC LAMINATE	VENEER	1,800	STONE	11,190
EDGE PROFILE	SELF EDGE	FACET EDGE	no charge	TAPER EDGE	no charge
GALLERY TOP FINISH	PLASTIC LAMINATE	VENEER	665	STONE	2,690
MODESTY / BASE PANEL FINISH	PLASTIC LAMINATE	VENEER	2,435		
PARTIAL MODESTY FEATURE	PLASTIC LAMINATE	VENEER	440		
ALUMINUM COMPONENTS FINISH	CLEAR ANODIZED	CHAMPAGNE ANODIZED	no charge	LT. BRONZE ANODIZED	no charge
GALLERY / PRIVACY SCREEN FINISH	PLASTIC LAMINATE	VENEER	665		
STORAGE ELEMENTS	NONE	1 BOX / 1 FILE MOBILE (qty=1)	2,685	2 BOX / 1 FILE MOVABLE (qty=1)	3030
POWER / VOICE / DATA OPTION	NONE	2 DUPLEX / 1 VOICE & 1 DATA	3,915	3 DUPLEX / 1 VOICE / 1 DATA	4,205
GROMMETS	PLASTIC 4" X 2" #70286	ALUMINUM 5" X 2.25" #70277	280	ALUMINUM 8" X 4.5" #70830	545
BOOK DROP	NONE	BOOK DROP	245	BOOK DROP + CART (P/L)	2,640
HEIGHT ADJUSTABLE ELEMENTS	NONE	ELECTRIC LIFT ELEMENT	2,590		
DESKTOP ACCESSORIES	NONE	LG PENCIL TRAY #70296	150	LG. PENCIL TRAY #70296	160
COMPUTER ACCESSORIES	NONE	CPU HOLDER #70632	140	CPU HOLDER #70637	685
TOTAL	\$26,215 LIST - PLUS OPTIONS				

VOX® CIRCULATION-RECEPTION DESK – CONFIGURATIONS

DESIGN – MARK MÜLLER

DESK 10

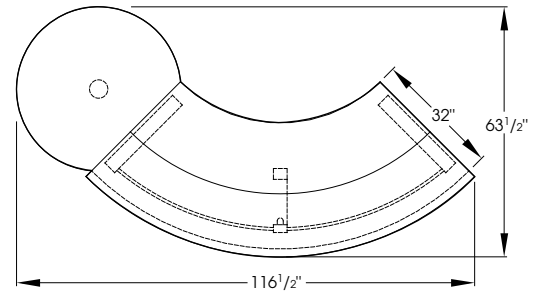
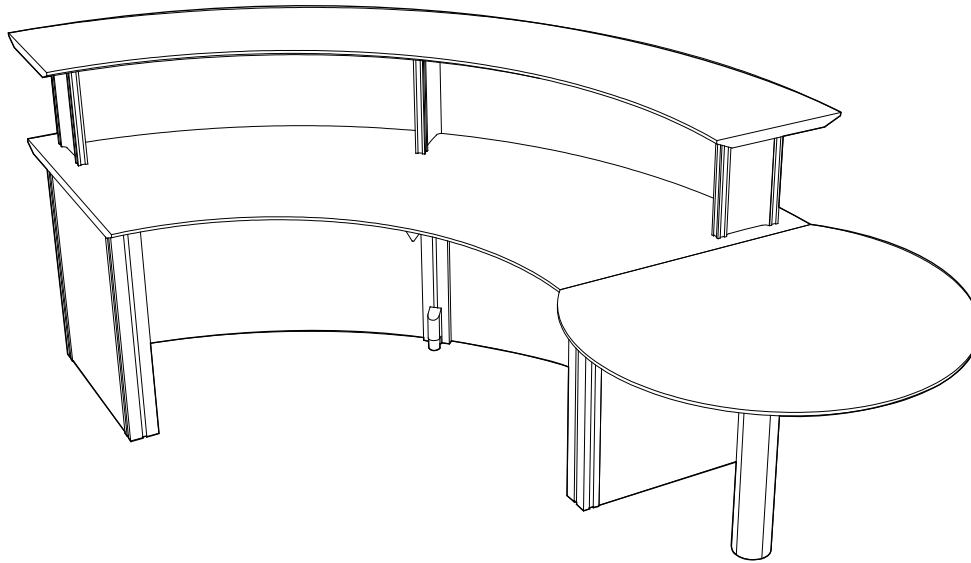

PLAN VIEW

Image shown with:

Option 2
Taper edge profile

FEATURES	STANDARD	OPTION 1	LIST PRICES	OPTION 2	LIST PRICES
TOP SURFACE	PLASTIC LAMINATE	VENEER	1,055	STONE	7,010
EDGE PROFILE	SELF EDGE	FACET EDGE	no charge	TAPER EDGE	no charge
GALLERY TOP FINISH	PLASTIC LAMINATE	VENEER	795	STONE	2,670
MODESTY / BASE PANEL FINISH	PLASTIC LAMINATE	VENEER	960		
PARTIAL MODESTY FEATURE	PLASTIC LAMINATE	VENEER	440		
ALUMINUM COMPONENTS FINISH	CLEAR ANODIZED	CHAMPAGNE ANODIZED	no charge	LT. BRONZE ANODIZED	no charge
GALLERY / PRIVACY SCREEN FINISH	PLASTIC LAMINATE	VENEER	530		
STORAGE ELEMENTS	NONE	1 BOX / 1 FILE MOBILE (qty=1)	2,685	2 BOX / 1 FILE MOVABLE (qty=1)	3,030
POWER / VOICE / DATA OPTION	NONE	2 DUPLEX / 1 VOICE & 1 DATA	1,315	3 DUPLEX / 1 VOICE / 1 DATA	1,415
GROMMETS	PLASTIC 4" X 2" #70286	ALUMINUM 5" X 2.25" #70277	280	ALUMINUM 8" X 4.5" #70830	545
BOOK DROP	NONE	BOOK DROP	245	BOOK DROP + CART (P/L)	2,640
HEIGHT ADJUSTABLE ELEMENTS	NONE				
DESKTOP ACCESSORIES	NONE	LG PENCIL TRAY #70296	150	LG. PENCIL TRAY #70296	160
COMPUTER ACCESSORIES	NONE	CPU HOLDER #70632	140	CPU HOLDER #70637	685
TOTAL	\$15,880 LIST - PLUS				
	OPTIONS				

VOX® CIRCULATION-RECEPTION DESK – CONFIGURATIONS

DESIGN – MARK MÜLLER

Vox Circulation-Reception Desk technical CAD drawings are available for download at www.nienkamper.com or www.nienkamperlibrary.com. Below is a sample selection of what the downloadable CAD drawing and PDF look like.

STANDARD DESK

VSD.0010		VSD.0020		VSD.0030		VSD.0040			VSD.0050			VSD.0060			VSD.0070		VSD.0080		VSD.0090			
LENGTH	WIDTH	LENGTH	WIDTH	LENGTH	WIDTH	LENGTH	WIDTH	RETURN	LENGTH	WIDTH	RETURN	LENGTH	WIDTH	RETURN	LENGTH	WIDTH	LENGTH	WIDTH	LENGTH	WIDTH	RETURN	
36	32	72	32	114	32	72	68	LEFT	102	68	LEFT	132	68	LEFT	112	68	198	68	198	68	60	
42		78		120		78	74	RIGHT	108	74	RIGHT	144	74	RIGHT	118	72	208	72	208	72	60	
48		84				84	80		114	80		158	80		124	78	220	78	220	78	72	
54		90				90	86		120	86		168	86		130	84	232	84	232	84	78	
60		96				96	92			92		180	92		136	90	244	90	244	90	84	
66		102				102	98			104		192	98		142	95	256	95	256	95	90	
		108				108	104			110		204	104		148	102	268	102	268	102	96	
							110			116		216	110		154	108	280	108	280	108	102	
												228	116		160	114	292	114	292	114	108	
												238	122		166	120	304	120	304	120	114	
												248	128		172							120
												258	134		178							
												268	140		184							
												278	146									
												288	152									

STANDARD DESK with RADIUS

VSD.0450		VSD.0460		VSD.0470			VSD.0480		VSD.0490		VSD.0500		
LENGTH	WIDTH	RETURN	LENGTH	WIDTH	RETURN	LENGTH	WIDTH	RETURN	LENGTH	WIDTH	LENGTH	WIDTH	RETURN
72	68	LEFT	102	68	LEFT	132	68	LEFT	112	68	198	68	60
78	74	RIGHT	108	74	RIGHT	144	74	RIGHT	118	72	208	72	60
84	80		114	80		158	80		124	78	220	78	72
90	86		120	86		168	86		130	84	232	84	78
96	92			92		180	92		136	90	244	90	84
				98		192	98		142	95	256	95	90
				104		204	104		148	102	268	102	96
				110		216	110		154	108	280	108	102
				116		228	116		160	114	292	114	108
						238	122		166	120	304	120	114
							128		172				120
							134		178				
							140		184				
							146						
							152						

STANDARD DESK with 60" x 60" RADIUS

VSD.0790		VSD.0800			VSD.0810			VSD.0820		VSD.0830		VSD.0840		
LENGTH	WIDTH	LENGTH	WIDTH	RETURN	LENGTH	WIDTH	RETURN	LENGTH	WIDTH	LENGTH	WIDTH	LENGTH	WIDTH	RETURN
80	80	95	95	LEFT	122	95	LEFT	150	95	150	150	150	150	LEFT
		102	102	RIGHT	132	102	RIGHT	162	102	162	162	162	162	RIGHT
		108	108		140	108		174	108	174	174	174	174	
		114	114		150	114		186	114	186	186	186	186	
		120	120		160	120		198	120	198	198	198	198	
		126	126		170	126		210	126	210	210	210	210	
		132	132		180	132		222	132	222	222	222	222	
		138	138		190	138		234	138	234	234	234	234	
		144	144		200	144		246	144	246	246	246	246	
		150	150		210	150		258	150	258	258	258	258	
		156	156		220	156		270	156	270	270	270	270	
		162	162		230	162		282	162	282	282	282	282	
		168	168		240	168		294	168	294	294	294	294	
		174	174		250	174		306	174	306	306	306	306	
		180	180		260	180		318	180	318	318	318	318	

VOX® END PANEL OPTIONS

DESIGN – MARK MÜLLER



Style 1

- Vertical Grain Direction
- Aluminum Trim



Style 2

- Vertical Grain Direction
- Aluminum Inlay
- Solid Edge on Sides



Style 3

- Box Pattern
- Alternating Vertical & Horizontal Grain Direction
- Solid Edge on Sides



Style 2.5

- Contrasting Veneer or Stained Border
- Vertical Grain Direction
- Aluminum Inlay
- Solid Edge on Sides

VOX® END PANEL OPTIONS

DESIGN – MARK MÜLLER

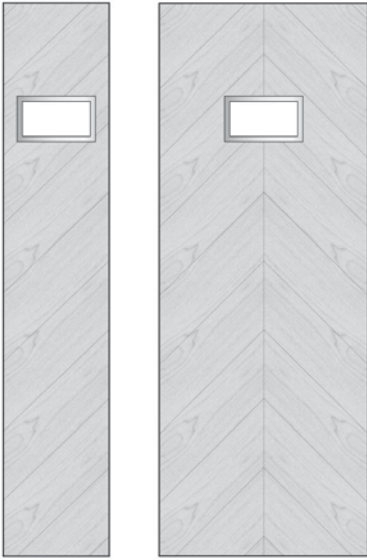

Style 4

- Herringbone Pattern
- Solid Edge on Sides



Style 5

- Vertical Grain Direction with Horizontal Stripes
- Solid Edge on Sides



Style 6

- Vertical Grain Direction with an Asymmetrical Horizontal Grain Box
- Solid Edge on Sides



Style 5.5

- Contrasting Veneer or Stained Stripes
- Vertical Grain Direction with Horizontal Stripes
- Solid Edge on Sides



Style 6.5

- Contrasting Veneer or Stained Box
- Vertical Grain Direction with an Asymmetrical Horizontal Grain Box
- Solid Edge on Sides

TERMS AND CONDITIONS OF SALE

PRICES

All prices are list prices, freight included, blanket-wrapped, dock delivered, from the manufacturing source to any location in the contiguous United States.

Brokerage is paid by Nienkämper for product shipped to the United States.

Due to existing conditions in regard to cost of labor and materials, we reserve the right to change prices without notice.

TERMS

Net 30 days from date of invoice to accredited buyers. Two per cent (2%) interest charged monthly on overdue accounts. Deposit of 50% is required with order. Terms will be established upon credit evaluation. Due to delays in processing references, first orders may be treated as C.B.D. orders.

ORDER CONFIRMATION

Orders are accepted upon issuance of our order confirmation and are subject to the terms set forth therein; notwithstanding any variance from the terms of the buyer's order form.

Nienkämper is not liable for any delay or failure to deliver caused by labor or transportation difficulties, accidents, acts of God, failure of sources of supply, or other causes beyond our control, and changes will affect the delivery date.

CHANGE OF ORDERS OR CANCELLATIONS

Changes or cancellations are subject to our ability to conform. A charge will be levied against cancelled or changed orders based on costs already incurred by Nienkämper. All changes must be in writing and submitted on a revised purchase order. Changes will affect the delivery date.

STORAGE

If goods cannot be accepted when ready, we may transfer them to storage (which is to be deemed as delivery for invoice purposes). The customer accepts risks and will be charged at prevailing rates.

FREIGHT

Prices include freight charges, blanket-wrapped, dock delivered, from the manufacturing source to any location in the contiguous United States. Packing and/or crating are available, if required, upcharges apply.

CLAIMS

All furniture is given to the carrier and signed for in good condition. It is the responsibility of the receiver to sign for the goods in the presence of the carrier and note the condition in which they are received. Freight claims should be filed with the carrier.

WARRANTY

There are no express or implied warranties, conditions and obligations of the manufacturer, whether statutory or otherwise that extend beyond the description on the face hereof. Our furniture is made to the highest standard and is warranted free from defects of material and workmanship for five years from the date of delivery. During the warranty period we will repair or replace such merchandise as shall prove to be defective, during normal usage in accordance with manufacturer's specifications. The manufacturer shall not be liable for defect wholly attributable to normal manufacturing process. Replacement or repair of the Product shall be the sole remedy of the Customer, and the manufacturer shall not be liable for any direct, indirect, incidental, or consequential loss or damage suffered by the Customer by reason of any defect in workmanship or manufacture of the Product or inability to use the Product. Moreover, this warranty does not cover accidental damage, abuse, alteration, ordinary wear and tear of Goods, negligence and misuse nor variations over which we have no control such as heat or humidity or damage to which the Goods are connected that is not attributable to the failure of the goods themselves. This warranty is null and void when the product is installed with hardware other than that supplied and/or when installed differently than recommended in the installation guide. Modification to the product or hardware may result in failure of the product and cause damage and/or injury.

WOOD FINISHES

Nienkämper offers a wide variety of standard light finishes on cherry, mahogany and figured anigre wood veneers, and a clear natural finish on figured anigre, figured sycamore, maple, bird's eye maple and curly maple.

Light finishes do not mask the grain and other characteristics of each wood species. It is important to understand that pieces of the same type of wood will not look identical when a light finish is used. The appearance of the finish will also depend on the natural color of the veneer. Cherry darkens over time as the wood ages. Pin knots and gum pockets are inherent traits.

Wood is a naturally variable raw material; its variances are not within the furniture manufacturer's control and are therefore not considered defects under this warranty.

